



Public pools - UVM, AOP v2026-04

# Chlorine-free technology for a healthy pools

Public pools

Public whirlpools

Medium-pressure UV

AOP (Advanced Oxidation Process)

# Content

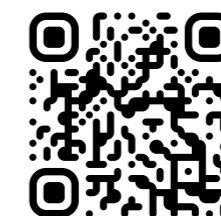
About Lifetech	4
Why work with us?	5
Health hazard risks in swimming pools	6
What is a healthy pool?	8
References	10

## Public pool 16

Medium-pressure UV technology	18
ProfiPure	20
ProfiTiny	22
Charm	24
Top	26
Clear PRO	28
AOP (Advanced Oxidation Process)	30
LifeOX® M	34

Summary	38
Public pool and whirlpool	39
Product comparison - technical parameters	40
Product comparison - health risks	42
Comparative technology - health risks	44

LESS CHLORINE  
MORE HEALTH



Haven't you received your catalog?  
Just scan the QR code and have it sent to  
your email.

# For more than 25 years, we've been helping our customers to enjoy a healthy swimming pool

We are an innovative and technological company from the heart of Europe. We have been helping our customers swim in a healthy pool for over 25 years. Nature is our greatest mentor. We harness its natural power inside our products for the most effective water Treatment today's technology can offer.

A pool equipped with our technology isn't just healthier; it is also up to 40% cheaper to maintain. To accomplish this mission, we design, develop, and manufacture the technology of ozone, UV, and their combination AOP. We train our distributors and partners to install, and reliably maintain these solutions. The synergy of UV and ozone represents

the latest and most efficient water disinfection technology available. This new and highly efficient technology is known as AOP, or Advanced Oxidation Process.

You can find our technology in thousands of residential pools, hundreds of hotel pools, and dozens of water parks worldwide.



## Why work with us?

### FROM US, YOU GET THE BEST SUPPORT

We understand that non-chlorine water disinfection technologies are still in their infancy. Therefore, we have developed a system to facilitate our partner a smooth entry into this field.

- You will receive clear and practical product and service training from us.
- You will receive ready-made marketing materials that you can take under your logo.
- We will support you quickly and reliably. We also keep all spare parts in stock.

### YOU CAN RELY ON OUR PRODUCTS

We know our products, therefore we can afford to give you the best product warranty on the market. Ask our sales team about the details.

Our confidence is based on our key strength, that is practical design and production craftsmanship.

### FROM US, YOU GET UNIQUE PRODUCT FEATURES

We can offer you several product features that are unique on the market. Among these features:

- LifeAGE technology prolongs lifespan of UV lamps by up to 125%.
- LifeAGE technology saves up to 50% of energy costs.
- LifeKEY is a unique technology that guarantees equipment reliability.

Interested in working with us? Great! Then do not hesitate to contact us on [becomeapartner@lifetechozone.com](mailto:becomeapartner@lifetechozone.com) our sales team will be happy to assist you.



# Health risks in swimming pools and their prevention



Technology LifeUVM®



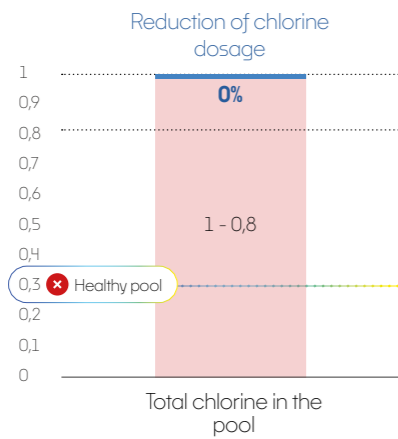
Technologie LifeOX® M

Health risk CHLORINATION ONLY

Health risk COMMON UV-C LIGHTS

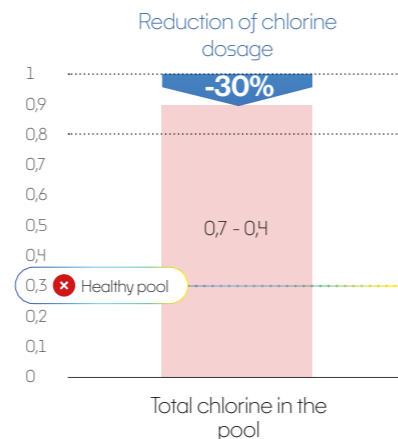
Healthy pool MEDIUM PRESSURE UV

Healthy pool AOP



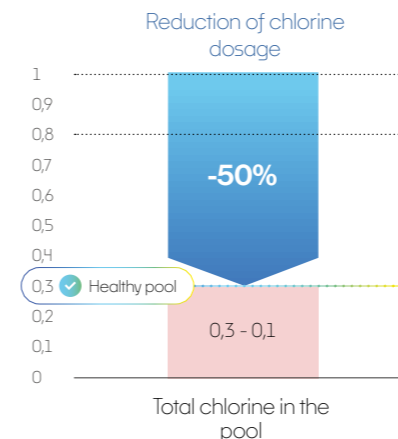
Swimming pool with high concentrations with trichloramines, NOT a healthy pool

The chemical compound trichloramine (Part of combined chlorine) becomes carcinogenic at high concentrations and can trigger asthma, allergies, skin irritation and dryness, and eye irritation. It is the compound behind the typical "chlorine" smell associated with swimming pools. In essence, a pool with a strong chlorine smell indicates high levels of bound chlorine and is NOT healthy. Additionally, trichloramine contributes to the corrosion of materials within swimming pools and indoor pool structures. Pools on chlorination and filtration only do are prone to chlorine-resistant bacteria such as *Pseudomonas aeruginosa*, *Legionella*, *Mycobacterium avium*, and *Cryptosporidium*. These bacteria can withstand typical chlorine concentrations found in pools and can cause severe or even deadly illnesses. The parasite *giardia lamblia* – causes severe diarrhoea



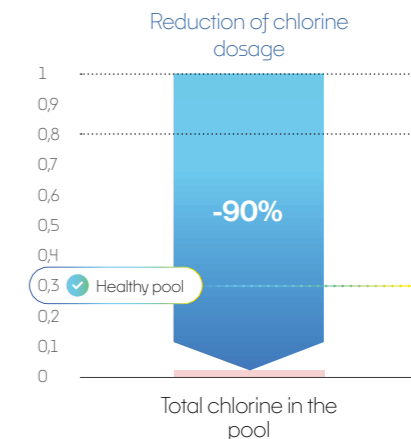
These lamps are based on low-pressure UV light bulbs with single wavelength of UV. These lamps do NOT remove the harmful trichloramine!

That harsh "chlorine pool" smell? It's actually trichloramine, a chemical compound of bound chlorine that is carcinogenic at higher concentrations and linked to asthma, skin irritation, and even damage to pool equipment. The concentration of disinfecting chlorine can be reduced to 0.5 mg/l. The concentration of disinfecting chlorine is 0.7-1 mg/l. Chlorine dosage 100%



Get a healthy swimming pool, removes the harmful Trichloramine

Ensure healthy water and a pleasant environment with UV systems featuring medium-pressure UV lamps, which simultaneously disinfect water and remove harmful Trichloramine. Standard low-pressure UV lamps cannot achieve this, which is why the German standard DIN 19643 for public swimming pool water treatment mandates the use of UV systems with medium-pressure lamps. This advanced technology, previously exclusive to public pools, is now available for private pools. It also allows for the reduction of disinfecting chlorine concentration to 0.3 mg/l.



Most powerful technology available. Get a healthy swimming pool, removes harmful Trichloramine and its source. Reduce TOC (Total organic carbon)

The pool water attains the quality of drinking water, creating a healthy and pleasant environment suitable even for toddlers, asthmatics, and allergy sufferers. It is free from harmful Trichloramine and organic TOC (Total Organic Carbon) contaminants. The concentration of disinfecting chlorine can be reduced to 0.1-0.2 mg/l. This results in a radical reduction of operating costs and the fastest return on investment.

# What is a healthy pool? Chemical-free technology. Minimizing the chemicals in the water plus reduction of monthly costs.

## TRICHLORAMINE = TOXIC SUBSTANCE

Trichloramine forms when chlorine reacts with nitrogen-containing substances such as sweat, body oils, and urine from swimmers.

## REDUCING RISKS TO HEALTH

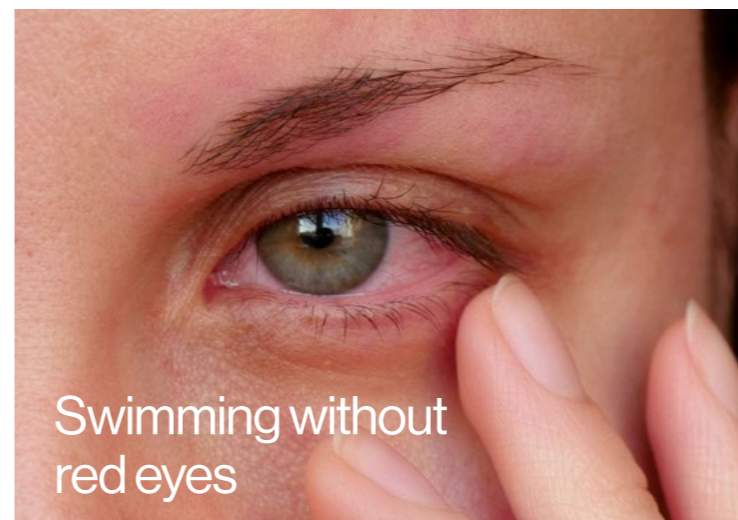
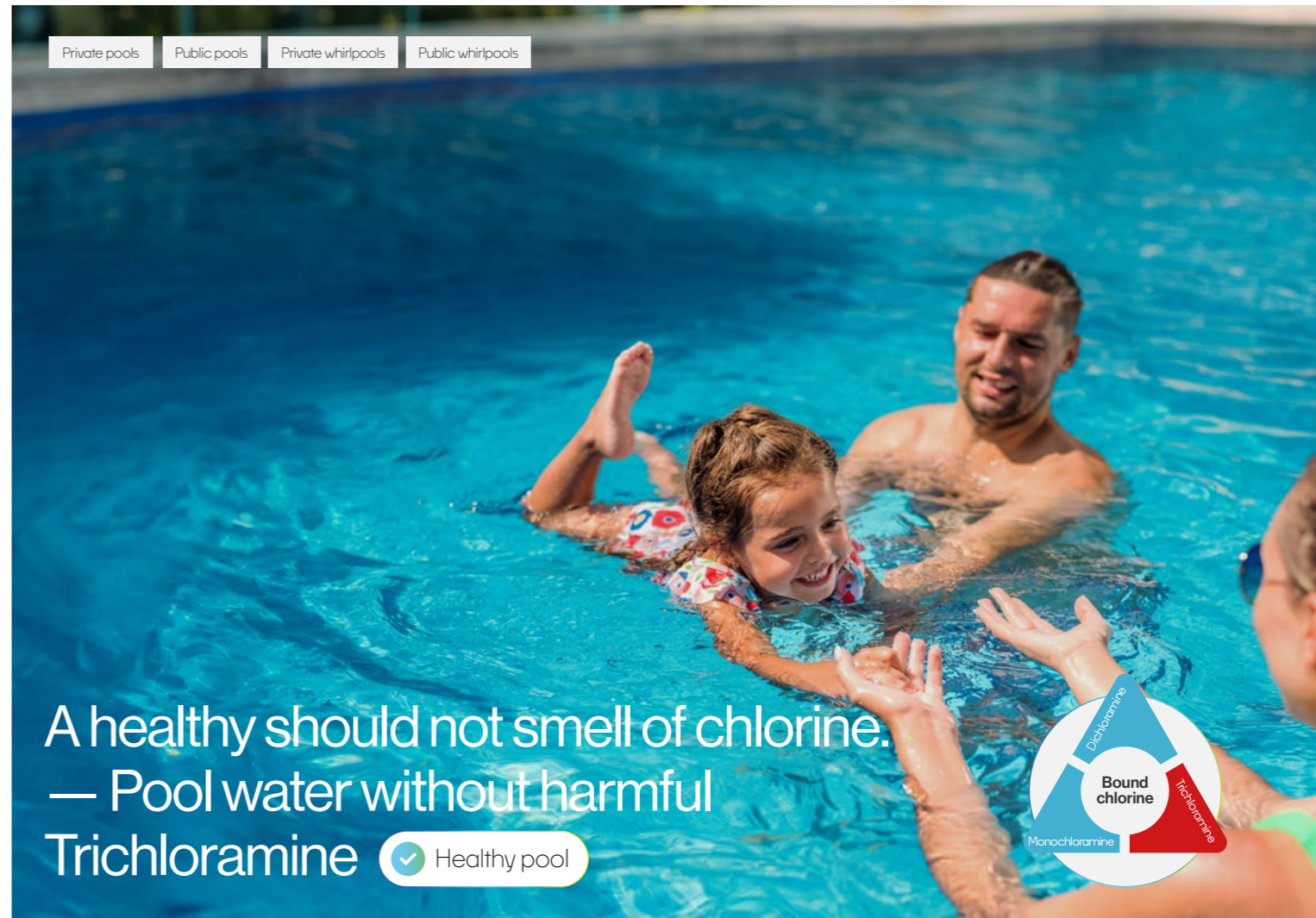
- Eye irritation
- Coughing and difficulty breathing
- Irritation and disruption of the epithelium of the upper respiratory tract
- Has been shown to contribute to the development of asthma and allergies
- Causes allergic reactions in sensitive individuals

## SKINCARE TECHNOLOGY

Prolonged exposure to trichloramine causes skin irritation and dryness, leading to premature aging.

## LESS CHLORINE = SAVED COSTS

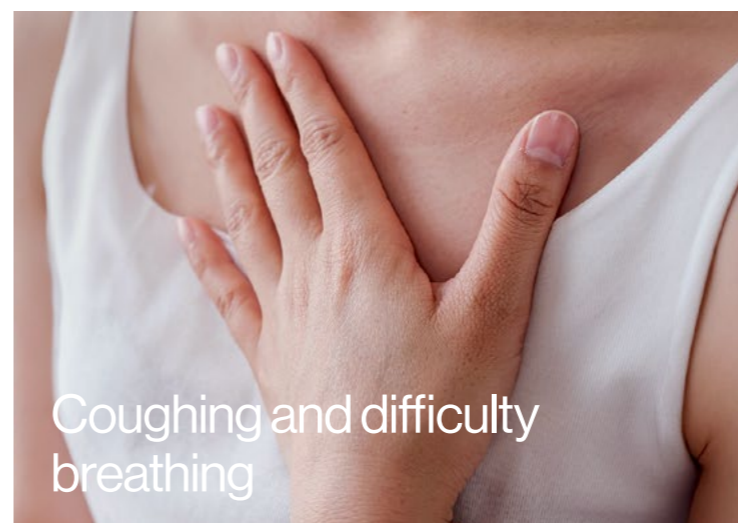
Reducing chemical consumption positively affects your monthly pool expenses



Swimming without red eyes



Irritation and drying of the skin



Coughing and difficulty breathing



Premature skin aging

3 426 pools enjoy healthy water with our equipment. 2 134 sites with solved water issues. 25 years of experience. Wherever there is Lifetech, there's a healthy pool.



## Sheybarah Island - Red Sea Global, Kingdom of Saudi Arabia

Lifetech supplied 38 medium pressure UV (UVM) Systems for the Sheybarah Island project (Part of Red Sea Global). In Red Sea Global (RSG), the convergence of luxury, sustainability, and innovation redefines the approach to development. The organization leads the way in pioneering new development and tourism models, with a primary focus on prioritizing the well-being of both people and the planet. Their projects are designed to actively contribute to enhancing the well-being of customers, communities, and environments alike. RSG is a cornerstone of Saudi Vision 2030, the most ambitious transformative investment and development project of our time.



## Lifetech technology in the Skjaak Swimming Pool - Norway

The installation of both the bypass for the ozone reaction/degassing tank and the medium pressure UV reactor in the mainstream was done very fast in the first day.

All the new equipment was very easy to fit to existing system. We mounted the LifeUVM0135WM medium pressure UV reactor on the optional reactor stand and the Control and power supply unit on an existing stand. The Lifepool 4.0 ozone generator and the Lifox 4.0 oxygen generator were mounted on the wall, the ozone reaction/degassing tank was floor mounted.

Installation of the LifeOX® technology from LIFETECH s.r.o. made possible to reach our goal, i.e. to reduce the chlorine content in the pool water.

The level of free chlorine is now kept at 0.2 ppm, thus, being reduced by close to 70 %. The combined chlorine content is as low as 0.05 ppm only. The strong smell of chlorine in the swimming pool is gone and the ambient air is much healthier. The pH level is very stable in the neutral range of pH 7.00-7.15. At these conditions, we have not found any trace of bacterial growth.



## TA'AKTANA, a Luxury Collection Resort & Spa, Labuan Bajo, Indonesia

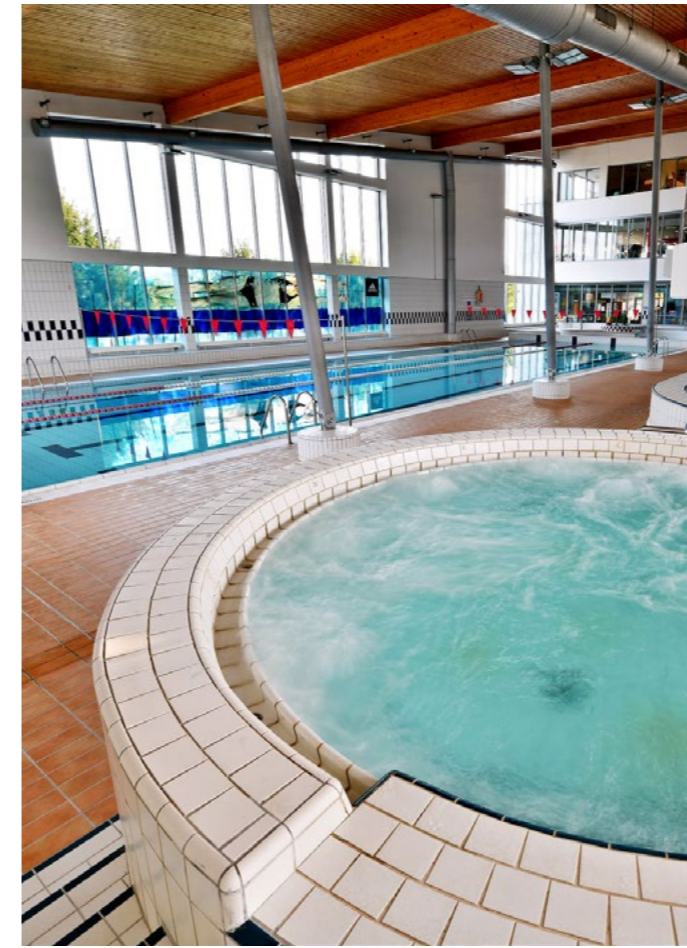
Lifetech supplied 4 medium pressure UV Systems for the hydrotherapy pools within the Wet Spa facility. This luxury hotel is a symbol of quality and high standard. Supplied by our partner SINAR TEKNIK, Medan/Indonesia



## Singapore Zoo is dedicated to the highest standards of animal care and conservation

Mandai Wildlife Reserve at Mandai in Singapore includes the Singapore Zoo, Night Safari, River Wonders, Bird Paradise and Rainforest Wild. This zoo has reputation as one of the best in the world and its well deserved. Mandai Reserve is a vast area with wild nature, home to 560 animal species, the number of animals is about 15,000. Singapore Zoo is dedicated to the highest standards of animal care and conservation, with a team of passionate wildlife professionals that look after all aspects of caring for the living collection.

It systematically introduces innovative technologies and sustainable practices, such as the use of renewable energy or the minimization of waste. This category also includes reducing water consumption, which our technology can repeatedly clean, treat and disinfect. We are really proud that our UV systems and LifeOX®-M technology have been chosen for such a prestigious Wildlife Reserve. We treat the water in 21 circuits, including pools for hippos, crocodiles, primates, otters, a pond for birds, etc.



## AquaDream Aquapark Barrandov - Prague

In February 2024, the original 4 medium-pressure UV systems were replaced by our TOP medium-pressure UV systems with unique LifeAGE® technology, which extends the life of medium-pressure lamps by more than 100% and simultaneously reduces operating costs by 20 to 30%. We are very pleased with the information that the hygiene authority staff measuring the water quality in Barrandov Aquapark could not believe that after replacing the original UV systems, there was such a radical improvement in water and air quality.



## The most modern polish Water Park Fabryka Wody uses LIFETECH technology

Twenty-six medium-pressure TOP UV systems with LifeAGE® technology were installed in the Fabryka Wody water park in Szczecin, Poland. The systems have a total capacity of almost 4,000 cubic meters of pool water per hour, and in addition to the perfect disinfection of the pool water, harmful trichloramines will also be removed. These are harmful to human health, causing the typical pool smell, asthma, red eyes, burning of the skin and corrosion of the halls. The environmentally friendly LifeAGE® technology is able to effectively eliminate these substances and at the same time minimize operating costs. The systems were commissioned in the second week of January 2024.

In addition to water fun, Fabryka Wody will also offer an educational section focused on water as a life-giving fluid from the point of view of the school curriculum of natural history, physics, chemistry and biology. The aim of this part of the water park is to contribute to the protection of the environment and natural resources in the form of education.

LIFETECH is proud that the LifeAGE® technology it developed was chosen for such a prestigious project. It is proof not only of its efficiency and reliability, but also of the growing emphasis on the need for energy savings and environmental protection.



## Lifetech technology in Zuri Zanzibar

LIFETECH is proud that the design and supply of ozone, UV and LifeOX<sup>®</sup>M technologies for the treatment of drinking, waste and pool water contributed to the fact that the unique ZURI Zanzibar resort was the first in the world to be awarded the gold EarthCheck certification for sustainable design.

LIFETECH has always designed environment-friendly technologies. They were invited by their long-term business partner, VTI, to design ozone and UV technology for all water and waste management of the newly built ZURI Zanzibar hotel resort in 2015. The aim was to use environmentally clean technologies for water treatment and to make the most of waste water recycling. In cooperation with VTI, LIFETECH designed and supplied technologies for the treatment of drinking, pool and waste water.

Water from boreholes undergoes mechanical and membrane filtration and subsequently enters two storage tanks. Each of them is 160 m<sup>3</sup> in size. Drinking water is disinfected with ozone. No chlorine is used for disinfection. Therefore, resort visitors drink tasty healthy water without a drop of chlorine. The supply also included a bottling plant enabling drinking water to be filled into glass bottles.

The LifeOX<sup>®</sup>M advanced oxidation technology treats water in all pools. It is the most efficient technology for pool water treatment. This technology includes the LifeUVM<sup>®</sup> medium-pressure systems with unique LifeAGE<sup>®</sup> technology to extend the life of medium-pressure UV lamps. The water of all whirlpools is treated using the Combi Ozone/UV system. It is a combined technology of ozone and low-pressure LifeUVL systems.

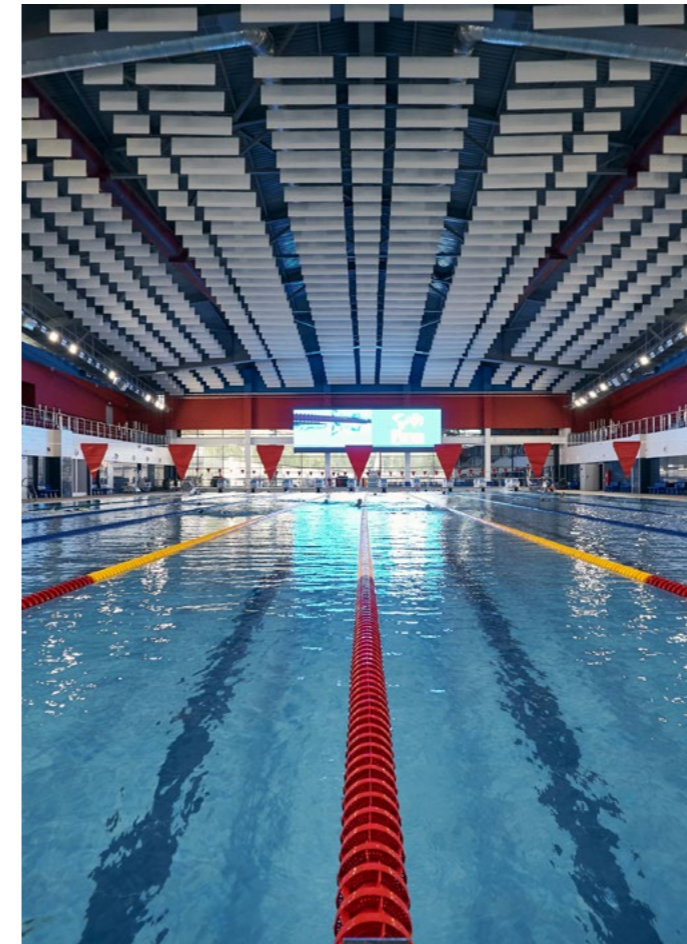
The maximum use of the produced water is achieved by disinfecting the water flowing out of the biological wastewater treatment plant using the advanced Combi Ozone/UV oxidation technology. The treated water is used for watering and also as a water source for the fire reservoir.

Our exclusive LifeOX<sup>®</sup>M and LifeAGE<sup>®</sup> technologies reduce the carbon footprint significantly compared to standard ozone and UV technologies. Additionally, these technologies bring competitive advantages to you and your clients. LifeOX<sup>®</sup>M is the most efficient technology for reducing and preventing the formation of harmful trichloramine in the pool water.



## Aquapalace Prague - Cestlice - The largest water park in the Czech Republic

We are proud that our best LifeOX<sup>®</sup>-M pool water treatment technology has been improving the quality of pool water and air since February 2024 even in the largest Czech water park Aquapalace Praha in Cestlice. We believe that our LifeOX<sup>®</sup>-M technology will also prove its qualities while reducing operating costs.



## Olympic swimming pool in Taldykorgan - Kazakhstan

A modern swimming pool complex in Taldykorgan, the administrative capital of the Jetisu Region, Kazakhstan. This unique project in Central Asia, was opened in the year 2021. Its uniqueness lies in the fact that it meets Olympic standards. Another feature is the external architectural appearance, reminiscent of the silhouette of a huge fish swimming in the depths of the sea. The complex has three swimming pools, the largest of which is 52 meters long and 25 meters wide. Total water flow of all three pools is almost 1000 m<sup>3</sup>/h and is treated by Lifetech AOP (Advanced Oxidation Process) technology LifeOX<sup>®</sup>-M.

# Public without compromise = The healthiest pool water, guaranteed by physics, not chemistry

*AOP reduces chemical consumption and costs. AOP create a healthy pool, where higher visitor attendance makes the difference.*



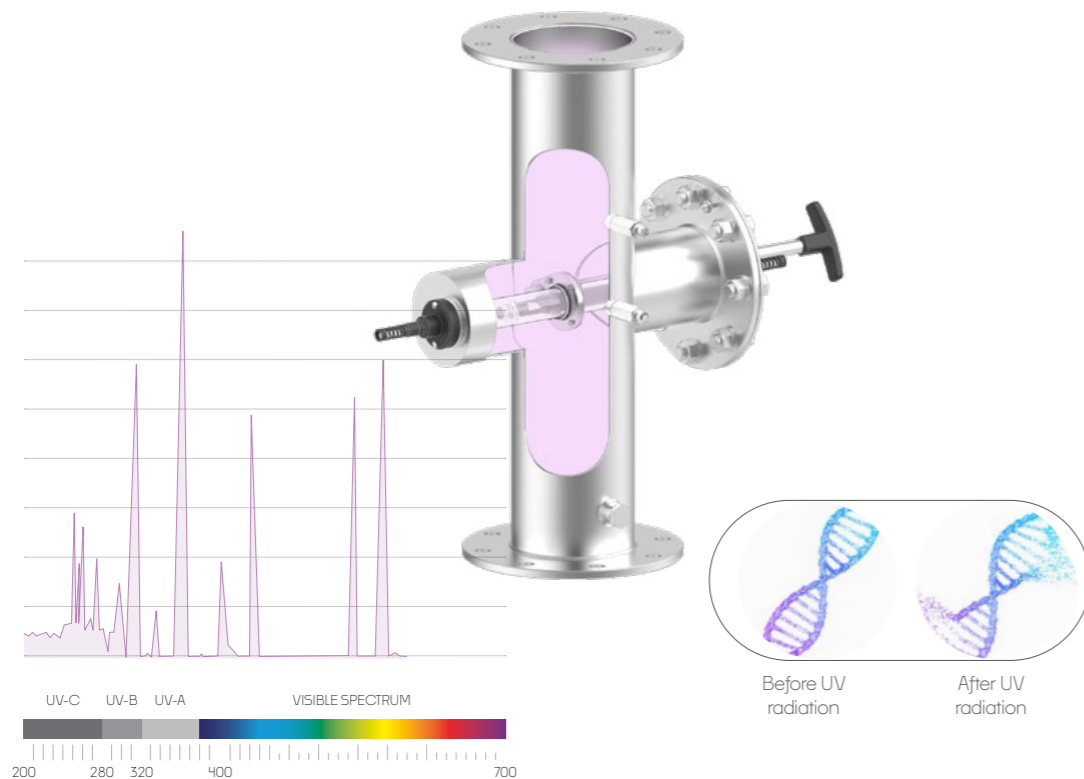
	ProfiPure	ProfiTiny	Charm	Clear PRO	Top	LifeOX® M
Expected life of UV lamp	5 000 hours	5 000 hours	10 000 hours	9 500 hours	18 000 hours	10 000 hours
Technology (Series)	Medium-pressure UV	Medium-pressure UV	Medium-pressure UV	Medium-pressure UV	Medium-pressure UV	AOP (Advanced Oxidation Process)
IoT	-	-	-	-	-	-
Salt water	Yes	Yes	Yes	Yes	Yes	Yes
Skincare technology (remove trichloramin)	Yes	Yes	Yes	Yes	Yes	Yes
Max flow rate Public pools and whirlpools (UV dose 60 mJ/cm <sup>2</sup> )	30 m <sup>3</sup> /h	44 m <sup>3</sup> /h	33 m <sup>3</sup> /h	910 m <sup>3</sup> /h	910 m <sup>3</sup> /h	250 m <sup>3</sup> /h / 1 unit*
Application	Indoor pools, Outdoor pools, Whirlpools	Indoor pools, Outdoor pools, Whirlpools	Indoor pools, Outdoor pools, Whirlpools	Indoor pools, Outdoor pools, Whirlpools	Indoor pools, Outdoor pools, Whirlpools	Indoor pools, Outdoor pools
TOC reduction	-	-	-	-	-	Yes
Power supply	Magnetic power supply	Magnetic power supply	Advanced electronic power supply (LifeAGE® technology)	Electronic power	Advanced electronic power supply (LifeAGE® technology)	Advanced electronic power supply (LifeAGE® technology)
Connection	1 1/2" - 3"	2" - 3"	2" - 3"	DN 125 - DN 400 (flange)	DN 125 - DN 400 (flange)	2" - DN 250 (flange)
Total power input of UV lamps	0.25 - 0.8 kW	0.4 - 0.8 kW	0.4 - 0.6 kW	1 - 18 kW	1 - 18 kW	1.8 - 9.0 kW
Wiper	Without wiper	Without wiper	Without wiper	Without wiper	Without wiper	Without wiper
	Automatic wiper	Automatic wiper	Automatic wiper	Automatic wiper	Automatic wiper	Automatic wiper
Sensor	Temperature	Temperature	Temperature sensor	Temperature sensor UV sensor Modbus connection TS touch display	Temperature sensor UV sensor Modbus connection TS touch display	Temperature sensor UV sensor Modbus connection TS touch display
Optional	UV sensor	UV sensor	UV sensor	-	-	-

\* More about the LifeOX® M modular system on page 34

# Medium-pressure UV technology — reduces pool chemicals, saves money

Medium-pressure UV lamps operate on the broad-spectrum radiation principle, spanning from 200 to 600 nm. This broad range of wavelengths enhances their effectiveness by increasing the number of

pathogens they can target. Furthermore, this broad-spectrum UV radiation permanently disrupts the DNA of microorganisms, preventing any possibility of DNA repair and reactivation.



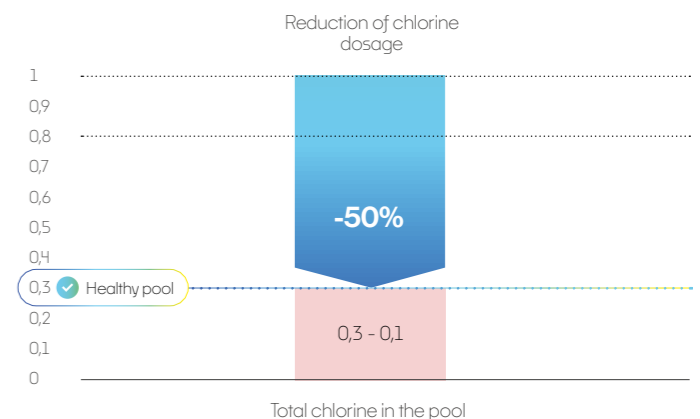
Medium Pressure UV makes your pool water crystal clear, odorless and healthy again

DIN 19643

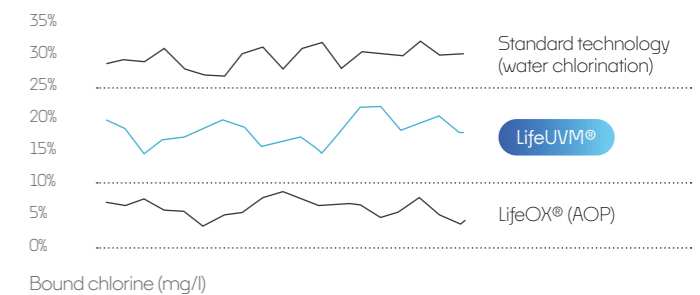
German standard for pools (DIN 19643)

Medium-pressure UVM systems are the only UV systems that reduce the value of bound chlorine in the pool - anchored in the German standard for pools. (DIN 19643)

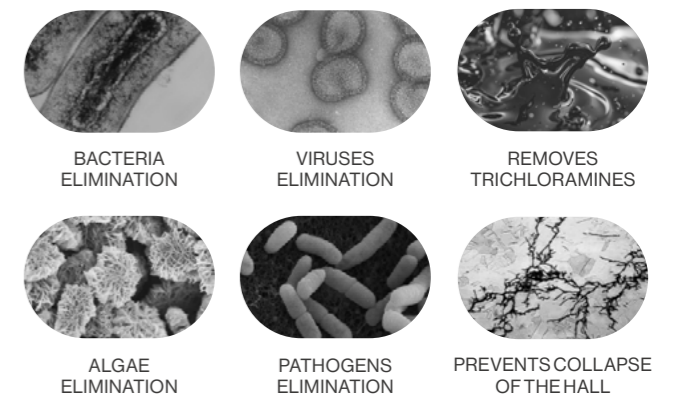
Fast ROI  
(Return On Investment)  
» Chlorine Reduction 50%



Independent measurement and testing took place in a public swimming pool in Bismo, Norway. (2007)



UV radiation eliminates the DNA of microorganisms permanently



# ProfiPure Smallest medium Pressure UV you can get

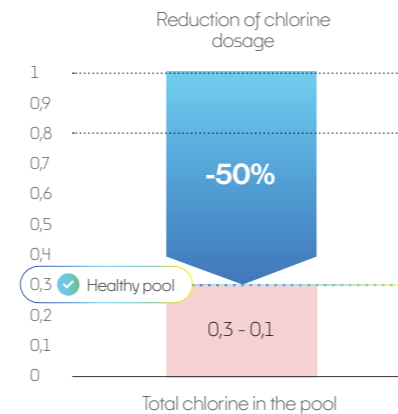
Permanent chlorine-free disinfection and elimination of unhealthy trichloramine in one compact system. Healthy pool technology. The first skincare UVM technology on the market,

which prevents aging of the skin. Minimizing the chemicals in the water plus reduction of monthly costs.

## Public pools: up to 30 m<sup>3</sup>/h



Expected life of UV lamp	5,000 hours
Technology (Series)	Medium-pressure UV systems (200–600 nm)
Application	Indoor pools Outdoor pools Whirlpools
Salt pool resistant (salt concentration up to 5kg/m <sup>3</sup> )	Yes
Max flow rate (UV dose 60 mJ/cm <sup>2</sup> )	30 m <sup>3</sup> /h
Power supply	Magnetic power supply
Connection	1 1/2"–3"
Total power input of UV lamps	0,25 - 0,8 kW
Wiper	Without wiper
Material	Stainless-steel reactor 316L (Salt water resistant)
Extension	Temperature sensor

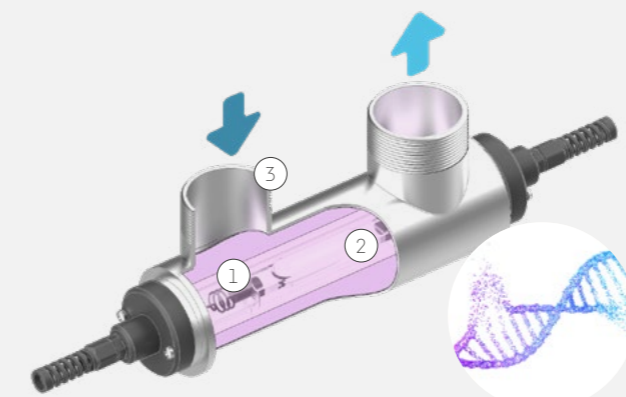


DIN 19643



## Smallest medium pressure UV you can get. Your health in your hands

The most compact design



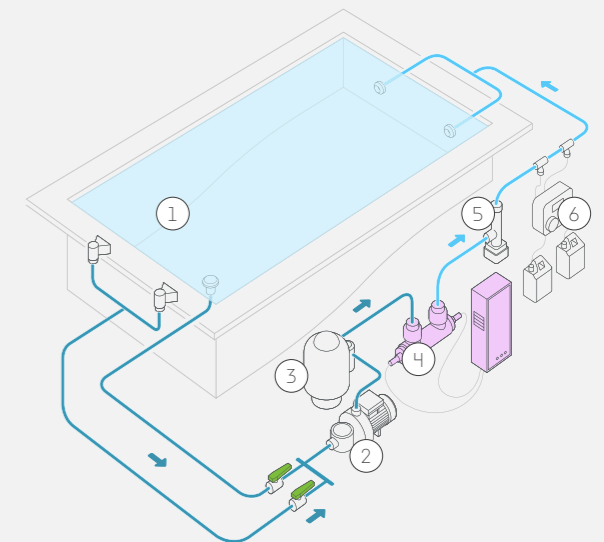
Bacterie DNA after UV radiation



- 1 UV lamp
- 2 Quartz sleeve
- 3 Stainless-steel reactor 316L (Salt water resistant)

Installation: fresh water and salt water pools

DIN 19643



- 1 Swimming pool
- 2 Circulator pump
- 3 Filter
- 4 ProfiPure
- 5 Heating
- 6 Chlorine dosage pH adjustment



### Models

Without wiper (NW)	Manual wiper (MW)	Automatic wiper (AW)	Connection	Max flow rate Public pools and whirlpools (m <sup>3</sup> /h) (UV dose 60 mJ/cm <sup>2</sup> )	Total power input of UV lamps (kW) / phase
ProfiPure 100	-	-	1 1/2"	4,7	0,25 / 1
ProfiPure 200	-	-	2"	4,7	0,25 / 1
ProfiPure 300	-	-	2"	9,0	0,25 / 1
ProfiPure 400	-	-	3"	15	0,40 / 1

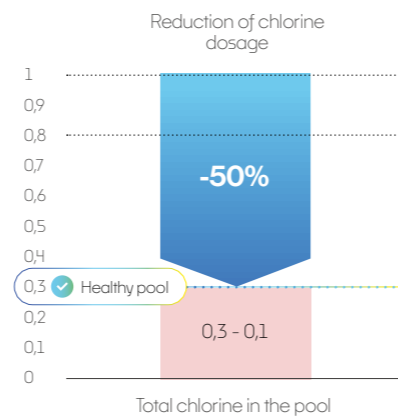
# ProfiTiny Medium Pressure UV with wiper

Permanent chlorine-free disinfection and elimination of unhealthy trichloramine in one compact system. Healthy pool technology. The first skincare UVM technology on the market, which prevents aging of the skin. Minimizing the chemicals in

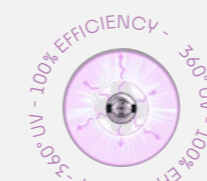
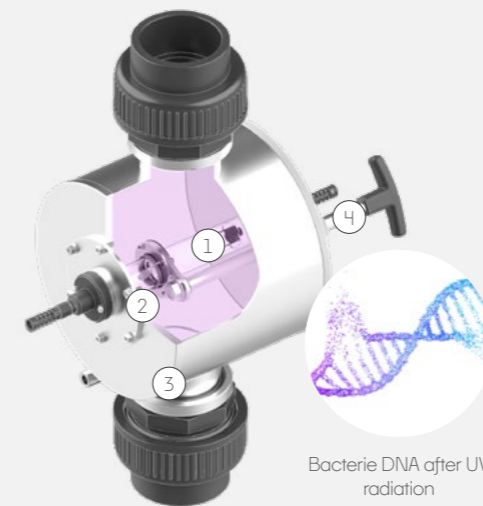
the water plus reduction of monthly costs. The manual wiper is an easy way to clean the surface of the quartz sleeves periodically to prevent energy losses and water treatment drops.



Expected life of UV lamp	5,000 hours
Technology (Series)	Medium-pressure UV systems (200–600 nm)
Application	Indoor pools Outdoor pools Whirlpools
Salt pool resistant (salt concentration up to 5kg/m <sup>3</sup> )	Yes
Max flow rate (UV dose 60 mJ/cm <sup>2</sup> )	44 m <sup>3</sup> /h
Power supply	Magnetic power supply
Connection	2"–3"
Total power input of UV lamps	0,4 - 0,8 kW
Wiper	Without wiper, Manual wiper
Material	Stainless-steel reactor 316L (Salt water resistant)
Extension	Temperature sensor

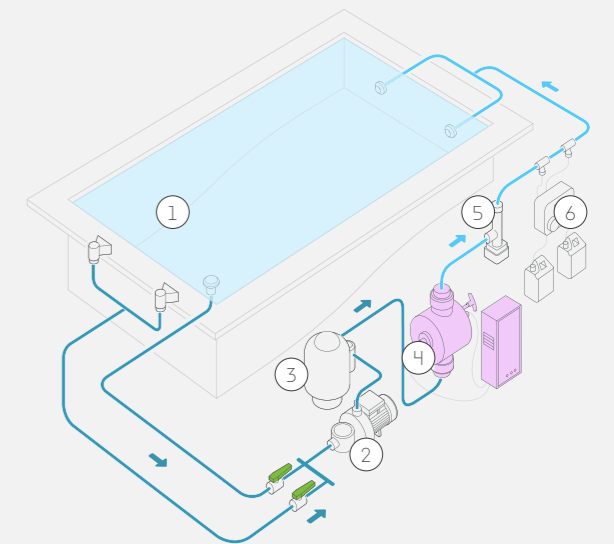


The most compact design with a manual wiper



- 1 UV lamp
- 2 Quartz sleeve
- 3 Stainless-steel reactor 316L (Salt water resistant)
- 4 Wiper

Installation: fresh water and salt water pools



- 1 Swimming pool
- 2 Circulator pump
- 3 Filter
- 4 ProfiTiny
- 5 Heating
- 6 Chlorine dosage pH adjustment



## Models

Without wiper (NW)	Manual wiper (MW)	Automatic wiper (AW)	Connection	Max flow rate Public pools and whirlpools (m <sup>3</sup> /h) (UV dose 60 mJ/cm <sup>2</sup> )	Total power input of UV lamps (kW) / phase
LifeUVM0104-13-NW-MP-LE	LifeUVM0104-13-MW-MP-LE	-	2"	16	0,4 / 1
LifeUVM0104-25-NW-MP-LE	LifeUVM0104-25-MW-MP-LE	-	3"	27	0,4 / 1
LifeUVM0204-25-NW-MP-LE	LifeUVM0204-25-MW-MP-LE	-	3"	44	0,8 / 1

# Charm

## Fully automatic

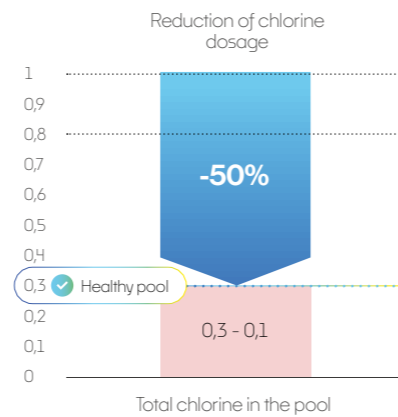
## Medium Pressure UV

Permanent chlorine-free disinfection and elimination of unhealthy trichloramine in one compact system. Healthy pool technology. The first skincare medium-pressure UV technology on the market, which prevents aging of the skin. Minimizing the chemicals in the water and reduction of monthly costs. The unique LifeAGE® technology will reduce

operating costs by up to 25% compared to standard UVM systems. Reduction of chlorine dose by up to 50%. Automatic wiper is the best way to clean the surface of the quartz sleeves periodically to prevent UV dose losses and water treatment drops.



Expected life of UV lamp	10,000 hours
Technology (Series)	Medium-pressure UV systems (200–600 nm)
Application	Indoor pools Outdoor pools Whirlpools
Salt pool resistant (salt concentration up to 5kg/m³)	Yes
Max flow rate (UV dose 60 mJ/cm²)	33 m³/h
Power supply	Advanced electronic power supply (LifeAGE® technology)
Connection	2"–3"
Total power input of UV lamps	0.4–0.6 kW
Wiper	Manual wiper, Automatic wiper
Material	Stainless-steel reactor 316L (Salt water resistant)
Extension	Temperature sensor

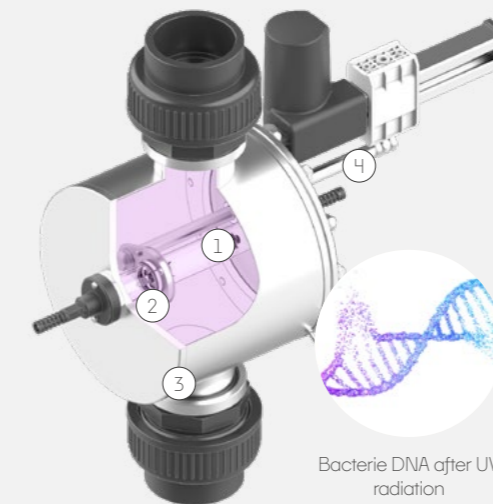


Public pools:  
up to 33 m³/h

100% UV efficiency.  
Water disinfection for healthy swimming.  
Advanced electronic power supply - LifeAGE®

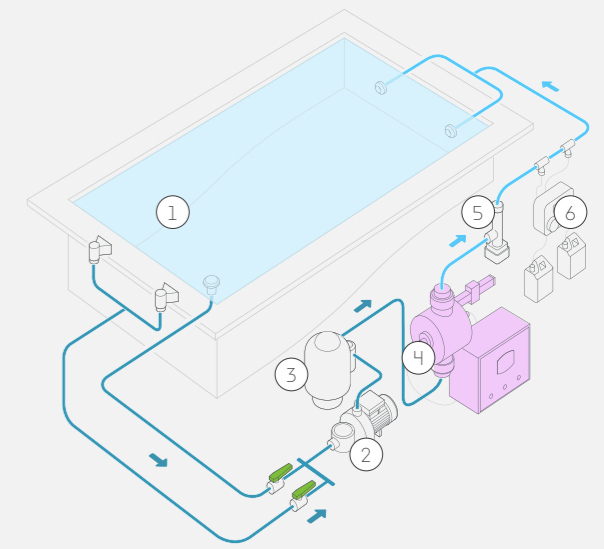
50% energy cost savings.  
125% lifespan of UV lamps

The most compact design with fully automatic wiper



- 1 UV lamp
- 2 Quartz sleeve
- 3 Stainless-steel reactor 316L (Salt water resistant)
- 4 Wiper

Installation: fresh water and salt water pools



- 1 Swimming pool
- 2 Circulator pump
- 3 Filter
- 4 Charm
- 5 Heating
- 6 Chlorine dosage pH adjustment



### Models

Without wiper (NW)	Manual wiper (MW)	Automatic wiper (AW)	Connection	Max flow rate Public pools and whirlpools (m³/h) (UV dose 60 mJ/cm²)	Total power input of UV lamps (kW) / phase
-	LifeUVM0104-13-MW-AEP-LD	LifeUVM0104-13-AW-AEP-LD	2"	16	0.4 / 1
-	LifeUVM0104-25-MW-AEP-LD	LifeUVM0104-25-AW-AEP-LD	3"	27	0.4 / 1
-	LifeUVM0106-25-MW-AEP-LD	LifeUVM0106-25-AW-AEP-LD	3"	33	0.6 / 1

# Clear PRO

## Pure Water. Pure Performance

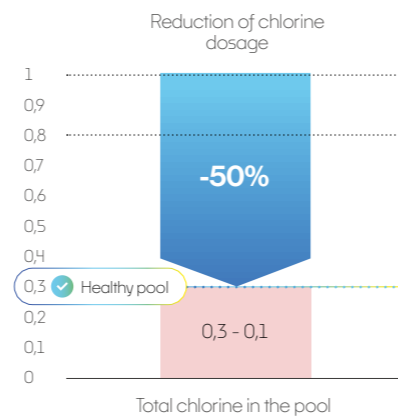
The advanced medium-pressure UV system on the market. Permanent Disinfection & Destruction of Unhealthy Trichloramine in One Compact System. Trichloramine causes: asthma, pool odor, red eyes, drying and burning

## Public pools: up to 910 m<sup>3</sup>/h

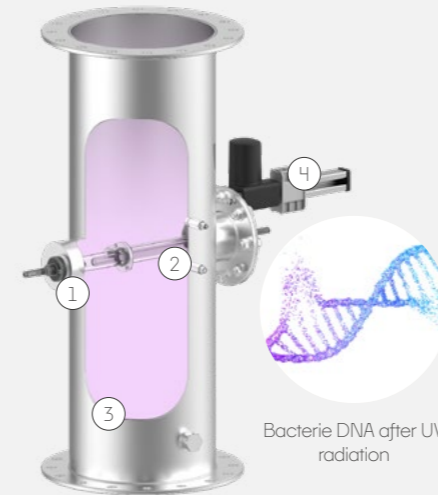
of the skin, and corrosion. Compared to standard UVM systems, this technology ensures superior hygiene and a significant reduction of chlorine dosage.



Expected life of UV lamp	9,500 hours
Technology (Series)	Medium-pressure UV systems (200–600 nm)
Application	Indoor pools Outdoor pools Whirlpools
Salt pool resistant (salt concentration up to 5kg/m <sup>3</sup> )	Yes
Max flow rate (UV dose 60 mJ/cm <sup>2</sup> )	up to 910 m <sup>3</sup> /h
Power supply	Electronic power
Connection	DN 125 - DN 400 (flange)
Total power input of UV lamps	1 – 18 kW
Wiper	Manual wiper, Automatic wiper
Material	Stainless-steel reactor 316L (Salt water resistant)
Extension	Temperature sensor, UV sensor, Modbus connection, TS touch display



### The advanced design



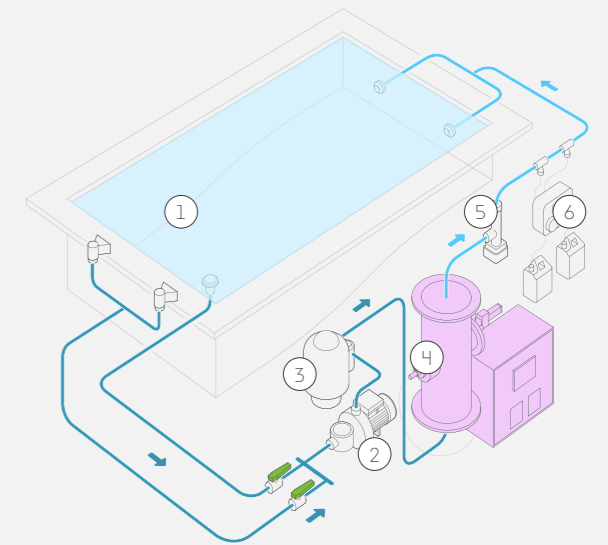
Bacterie DNA after UV radiation

- 1 UV lamp
- 2 Quartz sleeve
- 3 Stainless-steel reactor 316L (Salt water resistant)
- 4 Wiper

### Models

Without wiper (NW)	Manual wiper (MW)	Automatic wiper (AW)	Connection DN	Max flow rate - Public pools and whirlpools (m <sup>3</sup> /h) (UV dose 60 mJ/cm <sup>2</sup> )	Total power input of UV lamps (kW) / phase
-	LifeUVM0110-13-MW-EP-TS-D-DN125	LifeUVM0110-13-AW-EP-TS-D-DN125	125	35	1 / I
-	LifeUVM0110-16-MW-EP-TS-D-DN150	LifeUVM0110-16-AW-EP-TS-D-DN150	150	46	1 / I
-	LifeUVM0120-16-MW-EP-TS-D-DN150	LifeUVM0120-16-AW-EP-TS-D-DN150	150	63	2 / I
-	LifeUVM0120-21-MW-EP-TS-D-DN200	LifeUVM0120-21-AW-EP-TS-D-DN200	200	88	2 / I
-	LifeUVM0120-21-MW-EP-TS-D-DN150	LifeUVM0120-21-AW-EP-TS-D-DN150	150	88	2 / I
-	LifeUVM0130-27-MW-EP-TS-D-DN250	LifeUVM0130-27-AW-EP-TS-D-DN250	250	147	3 / I
-	LifeUVM0130-27-MW-AP-TS-D-DN150	LifeUVM0130-27-AW-EP-TS-D-DN150	150	147	3 / I
-	LifeUVM0130-32-MW-EP-TS-D-DN300	LifeUVM0130-32-AW-EP-TS-D-DN300	300	207	3 / I
-	LifeUVM0130-32-MW-EP-TS-D-DN250	LifeUVM0130-32-AW-EP-TS-D-DN250	250	207	3 / I
-	LifeUVM0230-27-MW-EP-TS-D-DN250	LifeUVM0230-27-AW-EP-TS-D-DN250	250	252	6 / III
-	LifeUVM0230-32-MW-EP-TS-D-DN300	LifeUVM0230-32-AW-EP-TS-D-DN300	300	315	6 / III
-	LifeUVM0230-32-MW-EP-TS-D-DN250	LifeUVM0230-32-AW-EP-TS-D-DN250	250	315	6 / III
-	LifeUVM0330-32-MW-EP-TS-D-DN300	LifeUVM0330-32-AW-EP-TS-D-DN300	300	462	9 / III
-	LifeUVM0430-32-MW-EP-TS-D-DN300	LifeUVM0430-32-AW-EP-TS-D-DN300	300	616	12 / III
-	LifeUVM0430-37-MW-EP-TS-D-DN350	LifeUVM0430-37-AW-EP-TS-D-DN350	350	630	12 / III
-	LifeUVM0430-40-MW-EP-TS-D-DN400	LifeUVM0430-40-AW-EP-TS-D-DN400	400	644	12 / III
-	LifeUVM0430-40-MW-EP-TS-D-DN350	LifeUVM0430-40-AW-EP-TS-D-DN350	350	644	12 / III
-	LifeUVM0530-40-MW-EP-TS-D-DN400	LifeUVM0530-40-AW-EP-TS-D-DN400	400	770	15 / III
-	LifeUVM0530-40-MW-EP-TS-D-DN350	LifeUVM0530-40-AW-EP-TS-D-DN350	350	770	15 / III
-	LifeUVM0630-40-MW-EP-TS-D-DN400	LifeUVM0630-40-AW-EP-TS-D-DN400	400	910	18 / III

### Installation: fresh water and salt water pools



- 1 Swimming pool
- 2 Circulator pump
- 3 Filter
- 4 Top
- 5 Heating
- 6 Chlorine dosage pH adjustment



# TOP direct Best UV you can get

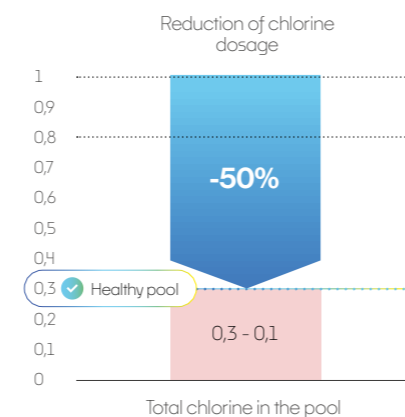
The most advanced medium-pressure UV system on the market. Permanent Disinfection & Destruction of Unhealthy Trichloramine in One Compact System with Unique LifeAGE® Technology. Trichloramine causes: asthma, pool odor, red eyes, drying and burning of the skin, corrosion. The unique LifeAGE® technology will reduce operating costs by up to 50%

# Public pools: up to 910 m³/h

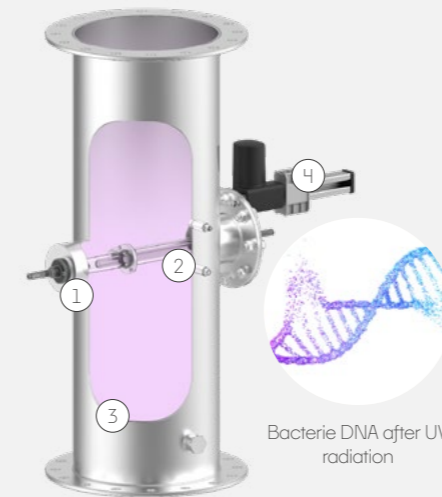
compared to standard UVM systems, extend the lifetime of UVM lamps by up to 100%, ensure automatic regulation of the UVM lamp radiation performance according to the current pool water pollution. Reduction of chlorine dosage by up to 50%.



Expected life of UV lamp	18,000 hours
Technology (Series)	Medium-pressure UV systems (200–600 nm)
Application	Indoor pools   Outdoor pools   Whirlpools
Salt pool resistant (salt concentration up to 5kg/m³)	Yes
Max flow rate (UV dose 60 mJ/cm²)	up to 910 m³/h
Power supply	Advanced electronic power supply - LifeAGE®
Connection	DN 125 - DN 400 (flange)
Total power input of UV lamps	1 – 18 kW
Wiper	Manual wiper, Automatic wiper
Material	Stainless-steel reactor 316L (Salt water resistant)
Extension	Temperature sensor, UV sensor, Modbus connection, TS touch display



The most advanced design with LifeAge technology

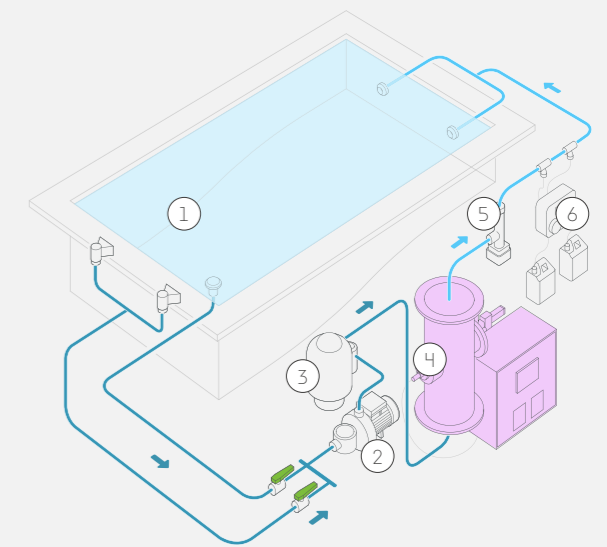


- 1 UV lamp
- 2 Quartz sleeve
- 3 Stainless-steel reactor 316L (Salt water resistant)
- 4 Wiper

## Models

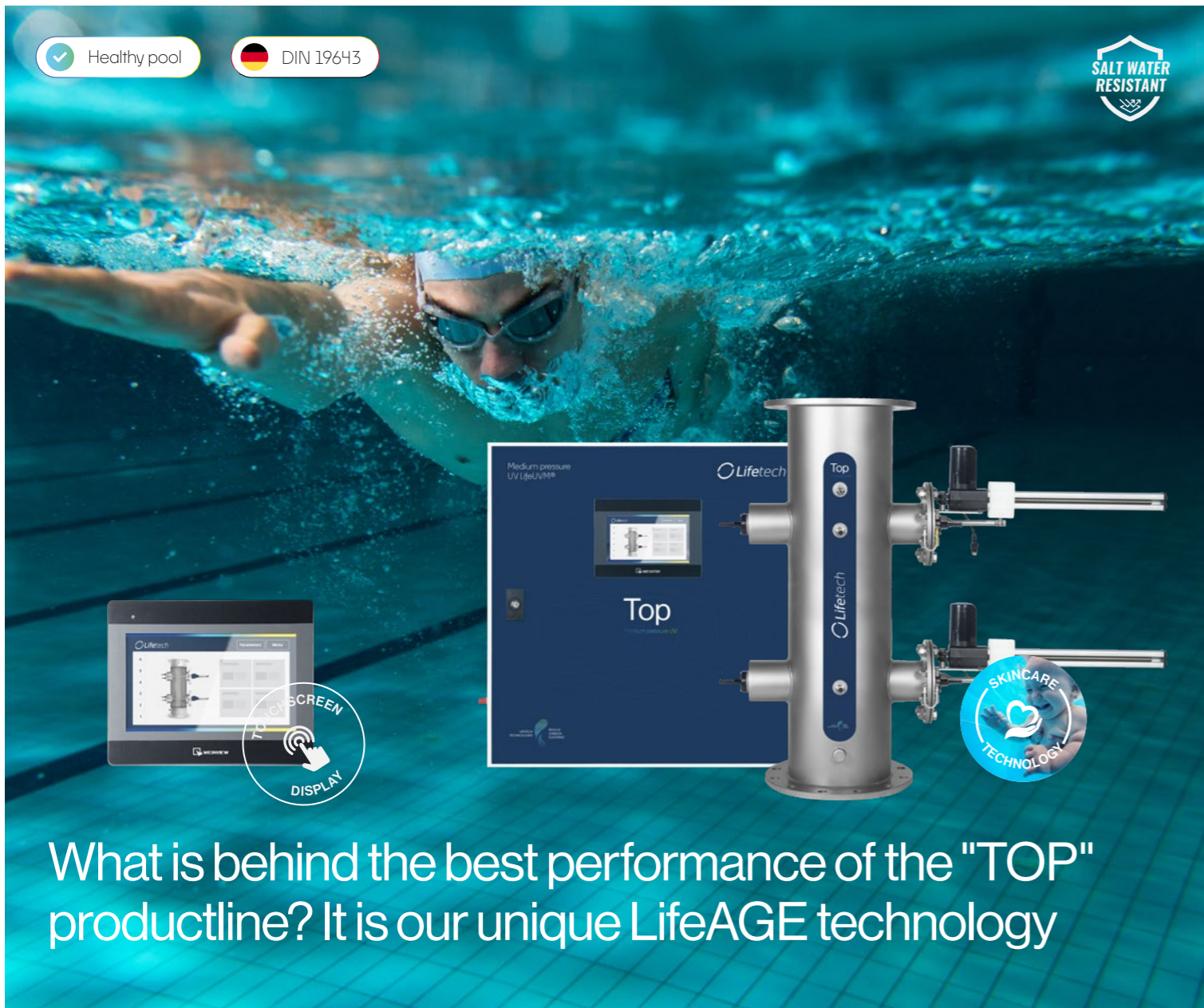
Without wiper (NW)	Manual wiper (MW)	Automatic wiper (AW)	Connection DN	Max flow rate - Public pools and whirlpools (m³/h) (UV dose 60 mJ/cm²)	Total power input of UV lamps (kW) / phase
-	LifeUVM0110-13-MW-AEP-TS-D-DN125	LifeUVM0110-13-AW-AEP-TS-D-DN125	125	35	1 / I
-	LifeUVM0110-16-MW-AEP-TS-D-DN150	LifeUVM0110-16-AW-AEP-TS-D-DN150	150	46	1 / I
-	LifeUVM0120-16-MW-AEP-TS-D-DN150	LifeUVM0120-16-AW-AEP-TS-D-DN150	150	63	2 / I
-	LifeUVM0120-21-MW-AEP-TS-D-DN200	LifeUVM0120-21-AW-AEP-TS-D-DN200	200	88	2 / I
-	LifeUVM0120-21-MW-AEP-TS-D-DN150	LifeUVM0120-21-AW-AEP-TS-D-DN150	150	88	2 / I
-	LifeUVM0130-27-MW-AEP-TS-D-DN250	LifeUVM0130-27-AW-AEP-TS-D-DN250	250	147	3 / I
-	LifeUVM0130-27-MW-AEP-TS-D-DN150	LifeUVM0130-27-AW-AEP-TS-D-DN150	150	147	3 / I
-	LifeUVM0130-32-MW-AEP-TS-D-DN300	LifeUVM0130-32-AW-AEP-TS-D-DN300	300	207	3 / I
-	LifeUVM0130-32-MW-AEP-TS-D-DN250	LifeUVM0130-32-AW-AEP-TS-D-DN250	250	207	3 / I
-	LifeUVM0230-27-MW-AEP-TS-D-DN250	LifeUVM0230-27-AW-AEP-TS-D-DN250	250	252	6 / III
-	LifeUVM0230-32-MW-AEP-TS-D-DN300	LifeUVM0230-32-AW-AEP-TS-D-DN300	300	315	6 / III
-	LifeUVM0230-32-MW-AEP-TS-D-DN250	LifeUVM0230-32-AW-AEP-TS-D-DN250	250	315	6 / III
-	LifeUVM0330-32-MW-AEP-TS-D-DN300	LifeUVM0330-32-AW-AEP-TS-D-DN300	300	462	9 / III
-	LifeUVM0430-32-MW-AEP-TS-D-DN300	LifeUVM0430-32-AW-AEP-TS-D-DN300	300	616	12 / III
-	LifeUVM0430-37-MW-AEP-TS-D-DN350	LifeUVM0430-37-AW-AEP-TS-D-DN350	350	630	12 / III
-	LifeUVM0430-40-MW-AEP-TS-D-DN400	LifeUVM0430-40-AW-AEP-TS-D-DN400	400	644	12 / III
-	LifeUVM0430-40-MW-AEP-TS-D-DN350	LifeUVM0430-40-AW-AEP-TS-D-DN350	350	644	12 / III
-	LifeUVM0530-40-MW-AEP-TS-D-DN400	LifeUVM0530-40-AW-AEP-TS-D-DN400	400	770	15 / III
-	LifeUVM0530-40-MW-AEP-TS-D-DN350	LifeUVM0530-40-AW-AEP-TS-D-DN350	350	770	15 / III
-	LifeUVM0630-40-MW-AEP-TS-D-DN400	LifeUVM0630-40-AW-AEP-TS-D-DN400	400	910	18 / III

Installation: fresh water and salt water pools



- 1 Swimming pool
- 2 Circulator pump
- 3 Filter
- 4 Top
- 5 Heating
- 6 Chlorine dosage pH adjustment





What is behind the best performance of the "TOP" productline? It is our unique LifeAGE technology



**Minimal operational expenses**

- Low power consumption
- Reduction of regular service costs (replacement of lamps, technician's work, transport)

**UV radiation intensity**

- Lowest required
- Stable production

**Versatile use**

- Maintains water quality even under extreme and variable loads

**Expected lifespan**

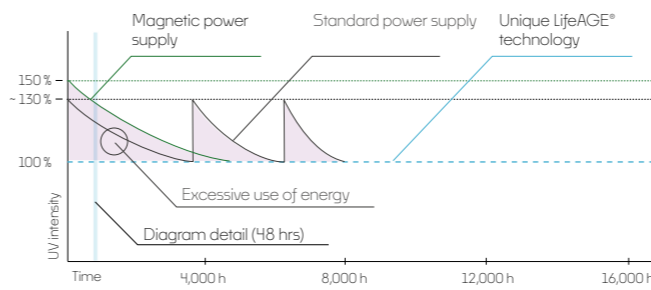
- Longest possible life of medium-pressure lamps
- Reducing the carbon footprint

The LifeAGE® technology automatically ensures the operation of the medium-pressure UVM system at all times with the lowest required UV power and power consumption.

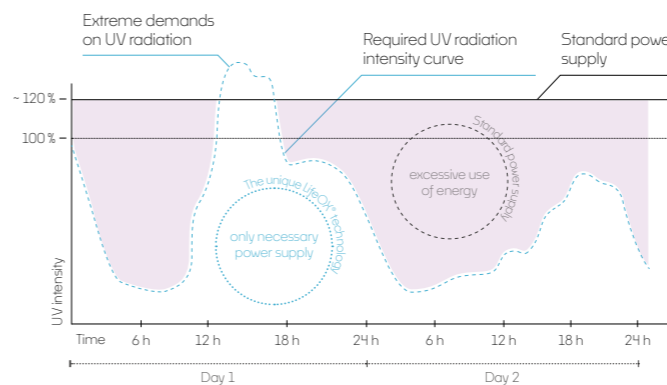
**LifeAGE saves up to 50% of energy costs.**

The magic lies in the dynamic release of energy needed to economically manage the intensity of UV radiation. The medium-pressure LifeUVM® system with the LifeAGE® technology emits UV intensity copying the minimum required radiation intensity curve. This system is autonomous and works in real-time. Therefore, it does not need to be connected to any external device that controls it to achieve this optimal intensity course. Therefore, the life of the UV lamp can be increased to up to 18,000 operating hours.

**Diagram**

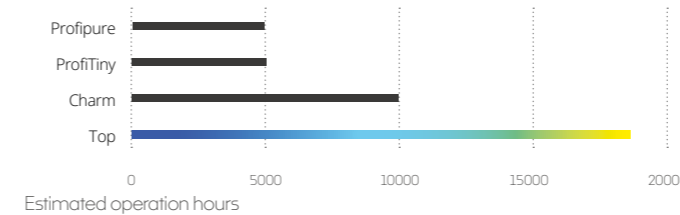


**Diagram detail (48 hrs)**

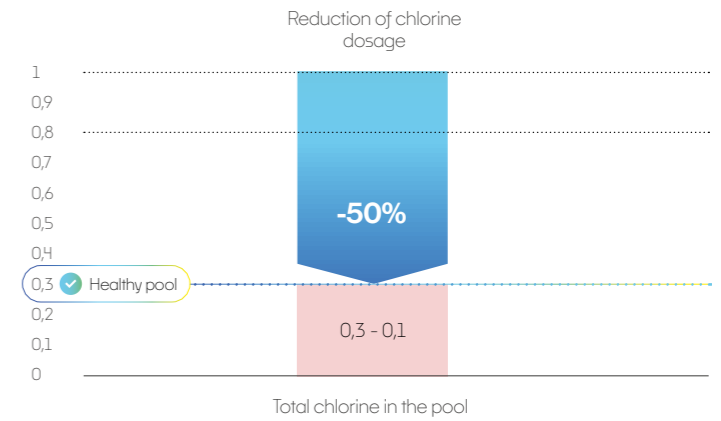


**LifeAGE prolongs lifespan of UV lamps by up to 125%**

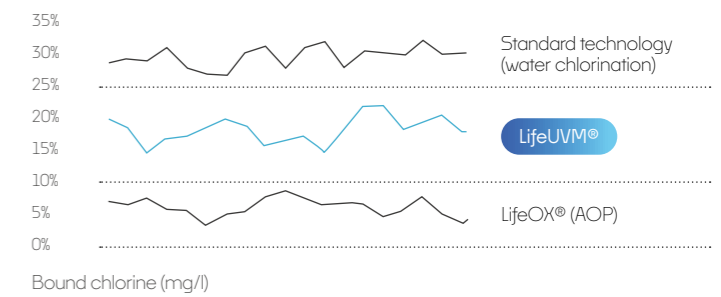
The magic lies in the dynamic release of energy needed to economically manage the intensity of UV radiation. The medium-pressure LifeUVM® system with the LifeAGE® technology emits UV intensity copying the minimum required radiation intensity curve. This system is autonomous and works in real-time. Therefore, it does not need to be connected to any external device that controls it to achieve this optimal intensity course. Therefore, the life of the UV lamp can be increased to up to 18,000 operating hours.



**Don't forget that you also save 50% on pool chemicals thanks to medium-pressure UV technology**



Independent measurement and testing took place in a public swimming pool in Bismo, Norway. (2007)



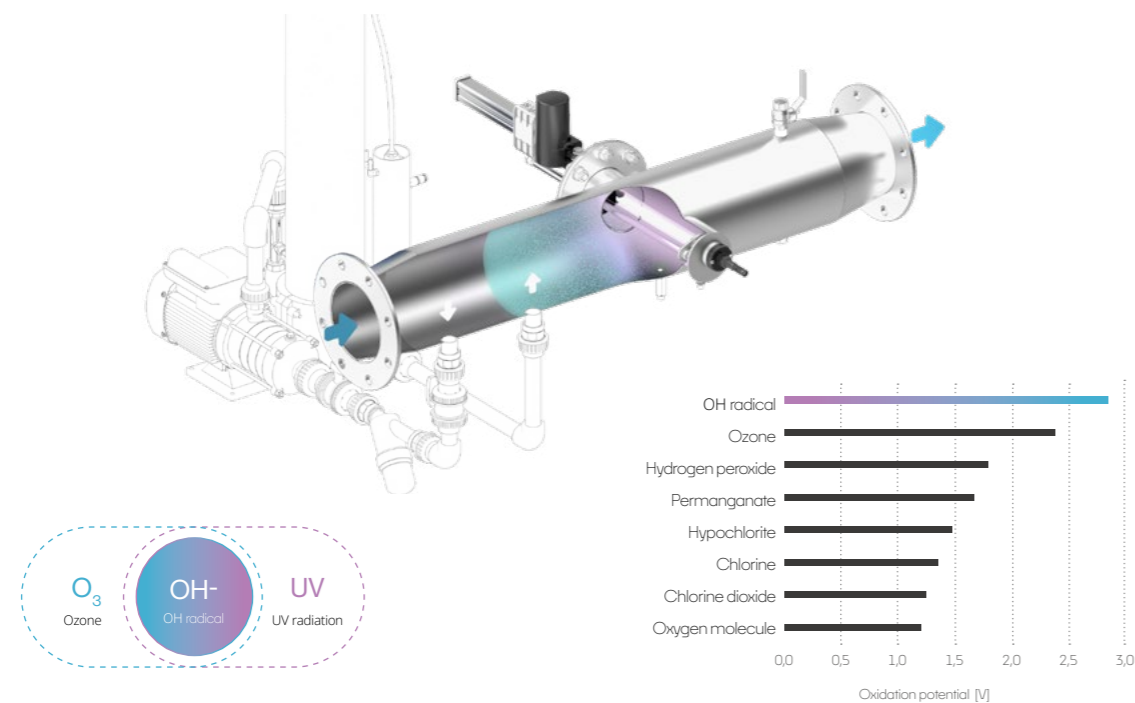
**What other products have LifeAGE technology?**



# AOP (Advanced Oxidation Process) — reduces pool chemicals, saves money

The advanced oxidation process (AOP) is today's best water treatment technology. AOP is based on the formation of OH-radicals in the water. These OH-radicals have considerably higher oxidation potential compared to other water treatment oxidants. This means that OH-radicals (i.e., AOP technology) are able to oxidise

particles in water much faster and more efficiently. The comparison can be found in the chart above. OH-radicals have a higher oxidation potential than hydrogen peroxide or ozone. The higher the oxidation potential, the more effective the oxidation of organic pollutants and the purification of water.



Healthy pool

## Skincare pool technology - skin protection from trichloramine

Healthy pool

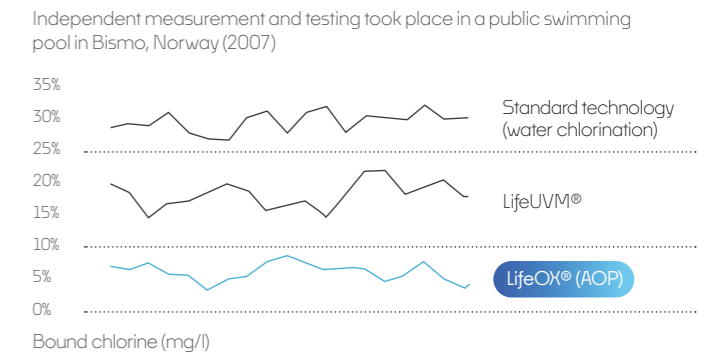
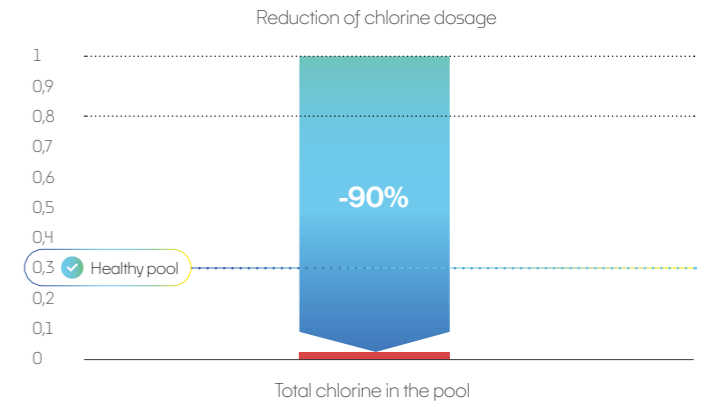
## The Advanced Oxidation Process (AOP) is today's most powerful and compact water treatment technology

The pool water achieves the quality of drinking water, a healthy and pleasant environment suitable even for toddlers, asthmatics and allergies.

Healthy pool

## Fastest ROI (Return On Investment)

### » Chlorine Reduction 90%



The higher the oxidation potential, the more effective the oxidation of organic pollutants and the purification of water.

- BACTERIA ELIMINATION
- VIRUSES ELIMINATION
- IRON AND MANGANESE OXIDATION
- ALGAE ELIMINATION
- PATHOGENS ELIMINATION
- HAZARDOUS CONTAMINANTS ELIMINATION
- REMOVES TRICHLORAMINES
- REMOVES TASTE AND ODOR
- REMOVES ORGANIC POLLUTANT TOC (TOTAL ORGANIC CARBON)
- ORGANIC POLLUTANTS (BTX, POPS, AOX, ETC.) ELIMINATION
- PREVENTS COLLAPSE OF THE HALL

# LifeOX® M

## The best technology money can get

Pool Water Purification & Prevention of Trichloramine Formation & TOC Reduction in One Compact System = the Most Effective Pool Water Treatment Technology with the Fastest Return on Investment. Trichloramine causes: asthma, pool odor, red eyes, drying and burning of the skin, corrosion.

TOC - the total amount of organic substances contaminating the water. Reducing TOC increases the amount of recyclable washing water after washing the filters = saving water and energy.



985x847x1202 mm

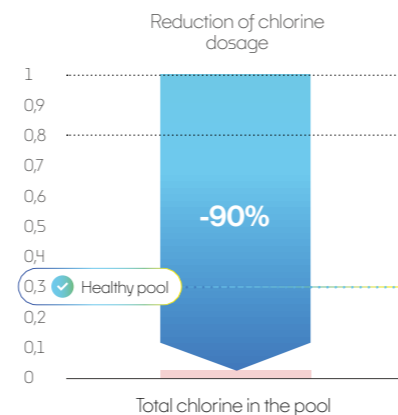


1,110x857x1,472 mm



1,300x1,300x2,000 mm

Technology	AOP (Advanced Oxidation Process)		
Application	Indoor pools	Outdoor pools	Whirlpools
Salt pool resistant (salt concentration up to 5kg/m <sup>3</sup> )	Yes		
Max flow rate	up to 250 m <sup>3</sup> /h		
Ozone generation	Air dryer, Oxygen concentrator		
Ozone generation technology	Corona discharge		
AOP technology	Ozone + UV		
UV lamp type	Medium-pressure LifeUVM®		
Power control	10–100%		
Installation	Plug & Play		
Connection system	In pipes (in-line), In by-pass		
Input power (kW)	1.8– 9.0		
Power supply	Advanced electronic power supply - LifeAGE®		
Wiper	Without wiper, Automatic wiper		
Material	Stainless-steel reactor 316L (Salt water resistant)		
Extension	Temperature sensor, UV sensor, Modbus connection, TS touch display		



Online animation about LifeOX® M®

## Public pools: up to 250 m<sup>3</sup>/h

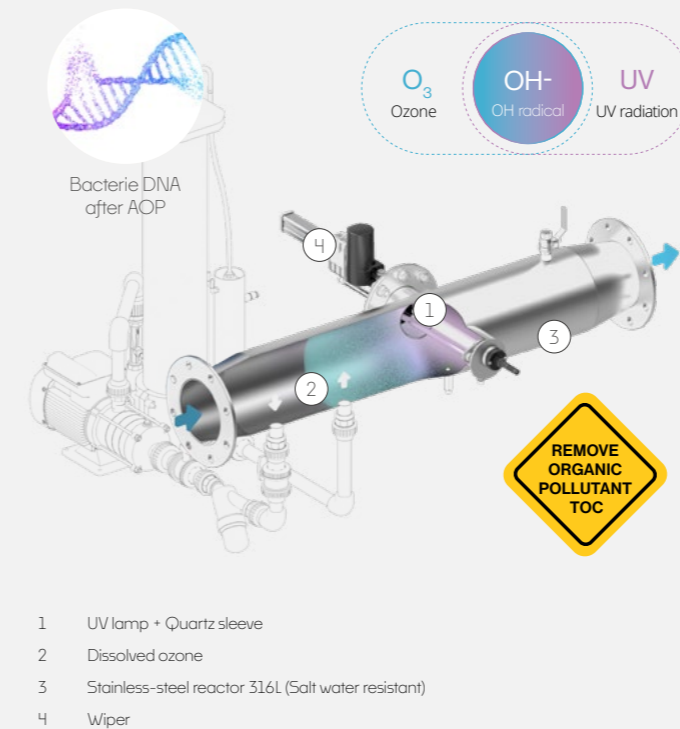
Healthy pool

Increased number of visitors due to healthy water and air in indoor pools. All with the power of nature, without added chemicals. Experience the power of AOP water treatment. Advanced electronic power supply - LifeAGE®

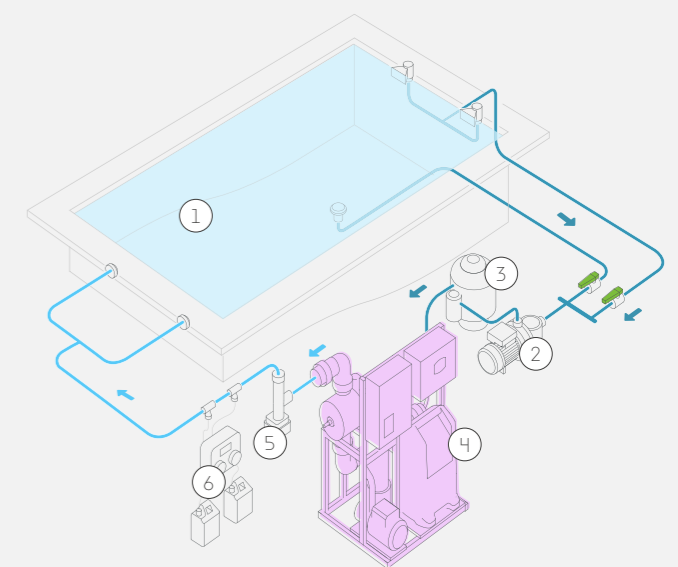


100% effectivity for Lifetime.

The most compact design for a industrial-grade AOP. Preventing trichloramine formation.



Installation: fresh water and salt water pools



### Modely

Model	Ozone generation	Connection	Total power input of UV lamps (kW)/phase	Max flow rate Public pools (m <sup>3</sup> /h)	Total power input of AOP (kW)	Dimensions (mm)	Weight (kg)
LifeOX® M10.EP	Air dryer	2"	0.4 / III	10	1.8	1063x740x1,334	120
LifeOX® M20.EP	Air dryer	2"	0.6 / III	20	2.0	1063x740x1,334	120
LifeOX® M40.EP	Oxygen concentrator	3"	0.6 / III	40	2.5	1,151x750x1,500	135
LifeOX® M90.EP	Oxygen concentrator	DN 150 (flange)	2 / III	90	3.9	1,300x1,260x1,800	250
LifeOX® M140.EP	Oxygen concentrator	DN 150 (flange)	3 / III	140	5.9	1,310x1,300x1,800	250
LifeOX® M250.EP	Oxygen concentrator	DN 250 (flange)	6 / III	250	9.0	1,310x1,300x1,800	280



Healthy pool DIN 19643

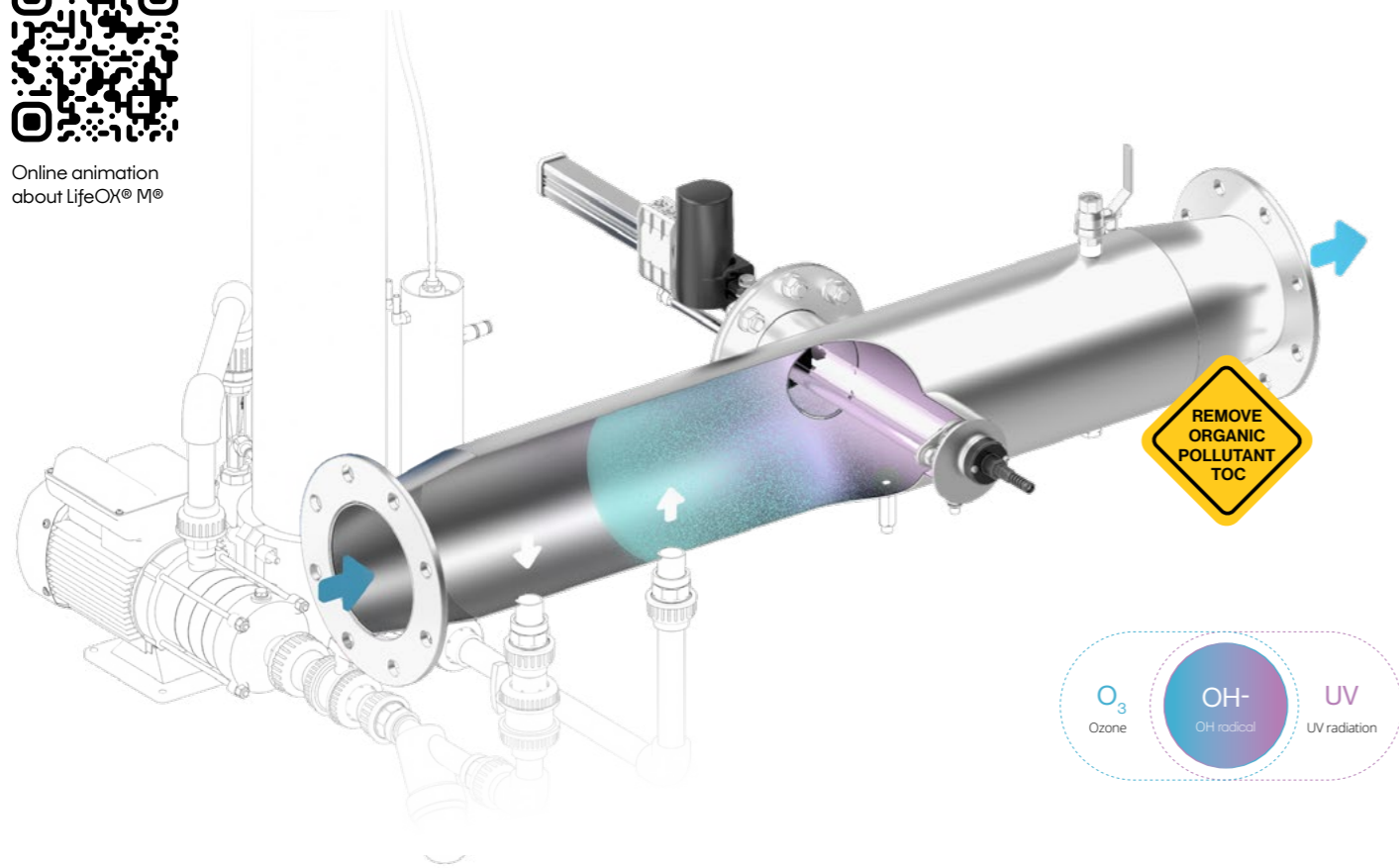
Why is LifeOX® M the revolution in pool disinfection?  
It's the synergic effect of combining Medium Pressure UV and ozone

TOUCHSCREEN  
DISPLAY

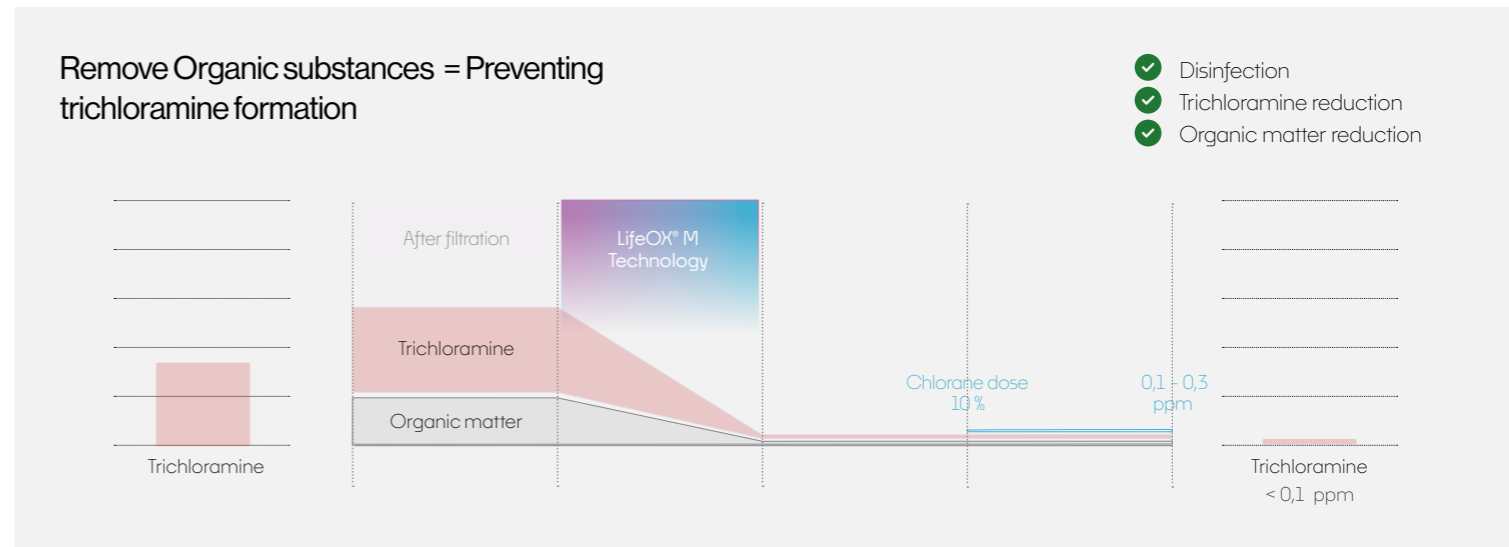
PREVENTING TRICHLORAMINE FORMATION



Online animation about LifeOX® M

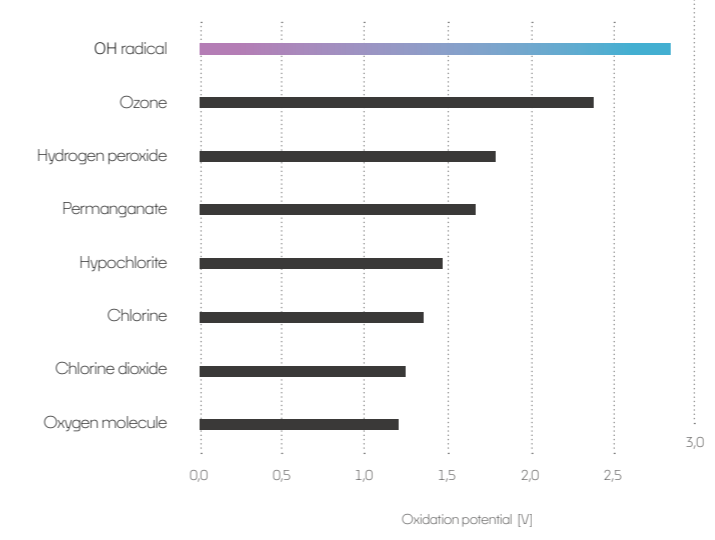


REMOVE ORGANIC POLLUTANT TOC



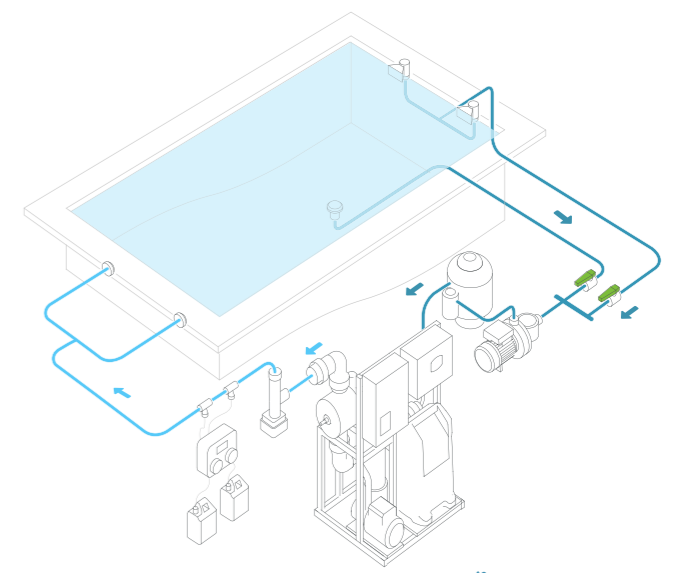
The higher the oxidation potential, the more effective the oxidation of organic pollutants and the purification of water.

The AOP is today's best available technology for pool water treatment, it eliminates hazardous substances and their root-cause. The result is crystal clear, healthy and odorless pool. This is our LifeOX®M technology, proven by our clients since 2007.

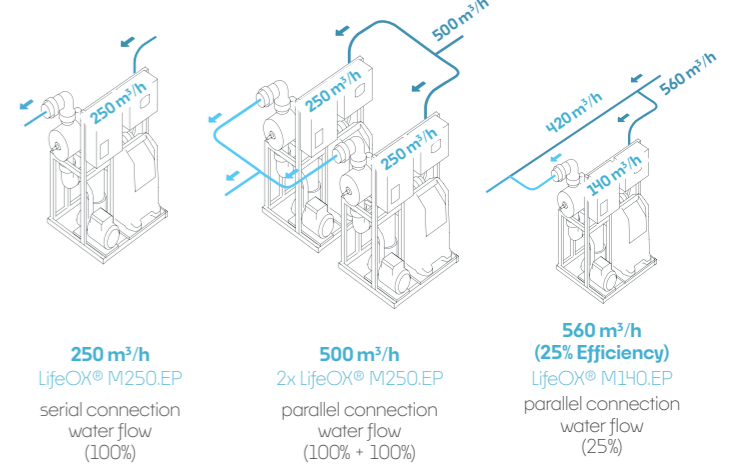
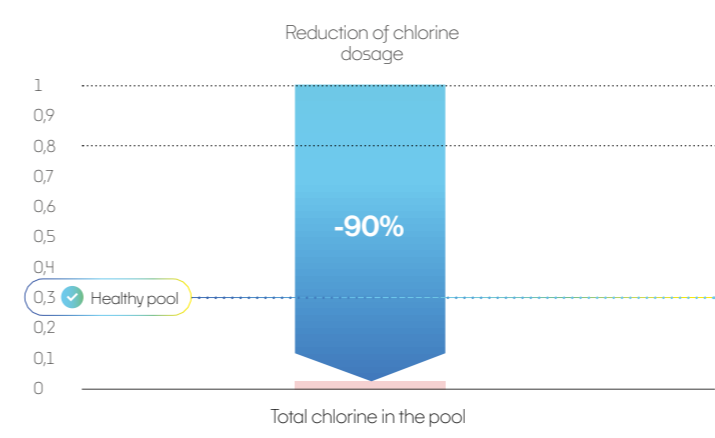


The LifeOX® M modular system treats any water flow, up to 250 m³/h per one system

LifeOX technology has been proven in aqua parks, toddler swimming pools, public whirlpools, swimming ponds and aquaculture. Increased number of satisfied visitors due to healthy water and enhanced air quality, making the pool suitable for asthmatics, allergics and toddlers. Prevents the Formation of Bound Chlorine and Trichloramine which Causes Asthma, Pool Odor, Red Eyes, Drying and Burning of the Skin, Corrosion



Don't forget that you also save 90% on pool chemicals thanks to AOP the technology

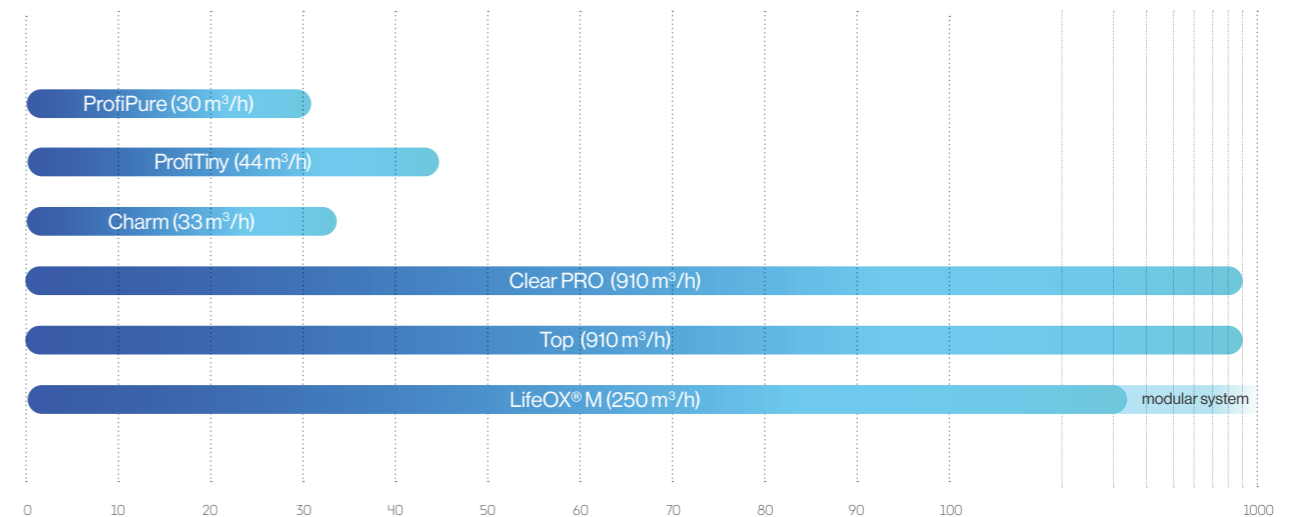


Clearly and in summary, choose what is best for you, and if you do not know, we will advise, contact to us










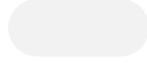
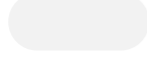


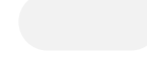
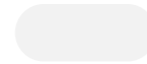


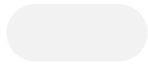


## Public pool and whirlpool



Max flow rate (m<sup>3</sup>/h)



# Product comparison - technical parameters

				
	ProfiPure	ProfiTiny	Charm	Clear PRO
Expected life of UV lamp	5 000 hours	5 000 hours	10 000 hours	9 500 hours
Technology (Series)	Medium-pressure UV	Medium-pressure UV	Medium-pressure UV	Medium-pressure UV
IoT	-	-	-	-
Salt water	Yes	Yes	Yes	Yes
Skincare technology (remove trichloramin)	Yes	Yes	Yes	Yes
Max pool private volume	294 m <sup>3</sup>	294 m <sup>3</sup>	252 m <sup>3</sup>	-
Max flow rate Private pools and whirlpools (UV dose 30 mJ/cm <sup>2</sup> )	49 m <sup>3</sup> /h	49 m <sup>3</sup> /h	42 m <sup>3</sup> /h	-
Max flow rate (m <sup>3</sup> /h) Public pools and whirlpools (UV dose 60 mJ/cm <sup>2</sup> )	30 m <sup>3</sup> /h	44 m <sup>3</sup> /h	33 m <sup>3</sup> /h	910 m <sup>3</sup> /h
Application	Indoor pools, Outdoor pools, Whirlpools	Indoor pools, Outdoor pools, Whirlpools	Indoor pools, Outdoor pools, Whirlpools	Indoor pools, Outdoor pools, Whirlpools
TOC reduction	-	-	-	-
Power supply	Magnetic power supply	Magnetic power supply	Advanced electronic power supply (LifeAGE® technology)	Electronic power
				
Connection	1 1/2"-3"	2"-3"	2"-3"	DN 125 – DN 400 (flange)
Total power input of UV lamps	0.25 - 0.8 kW	0.4 - 0.8 kW	0.4 - 0.6 kW	1 – 18 kW
Wiper	Without wiper  Manual wiper  Automatic wiper 	Without wiper  Manual wiper  Automatic wiper 	Without wiper  Manual wiper  Automatic wiper 	Without wiper  Manual wiper  Automatic wiper 
Sensor	Temperature	Temperature	Temperature sensor	Temperature sensor UV sensor Modbus connection TS touch display
Optional	UV sensor	UV sensor	UV sensor	-

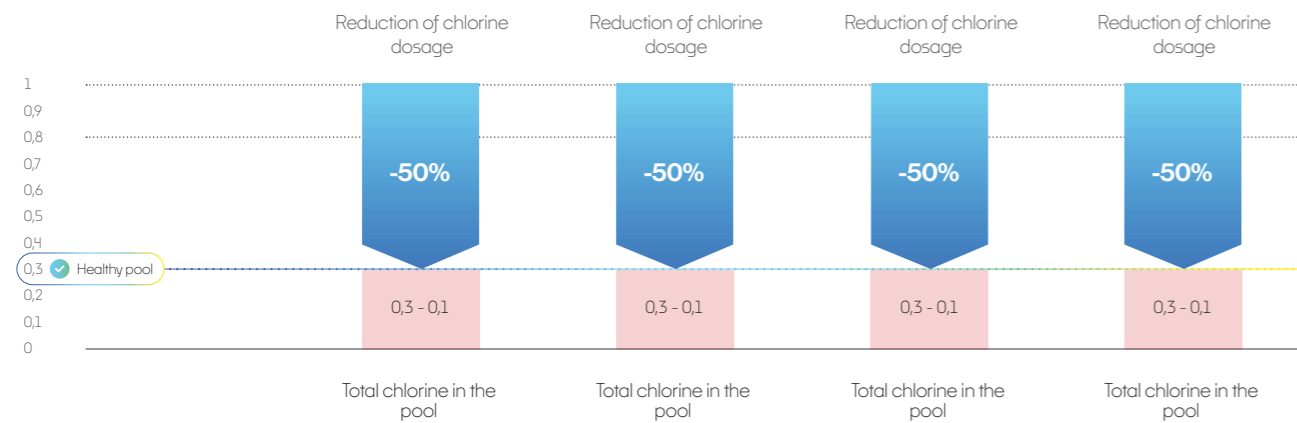
			
Top	LifeOX® M 10, 20	LifeOX® M 40	LifeOX® M 90, 140, 250
18 000 hours	10 000 hours	10 000 hours	10 000 hours
Medium-pressure UV	AOP (Advanced Oxidation Process)	AOP (Advanced Oxidation Process)	AOP (Advanced Oxidation Process)
-	-	-	-
Yes	Yes	Yes	Yes
Yes	Yes	Yes	Yes
-	120 m <sup>3</sup>	240 m <sup>3</sup>	1500 m <sup>3</sup>
-	20 m <sup>3</sup> /h /1 unit	40 m <sup>3</sup> /h /1 unit	250 m <sup>3</sup> /h /1 unit
910 m <sup>3</sup> /h	20 m <sup>3</sup> /h /1 unit	40 m <sup>3</sup> /h /1 unit	250 m <sup>3</sup> /h /1 unit
Indoor pools, Outdoor pools, Whirlpools	Indoor pools, Outdoor pools, Whirlpools	Indoor pools, Outdoor pools	Indoor pools, Outdoor pools
-	Yes	Yes	Yes
Advanced electronic power supply (LifeAGE® technology)	Advanced electronic power supply (LifeAGE® technology)	Advanced electronic power supply (LifeAGE® technology)	Advanced electronic power supply (LifeAGE® technology)
			
DN 125 – DN 400 (flange)	2"	3"	DN 125 – DN 250 (flange)
1 – 18 kW	1.8– 9.0 kW	1.8– 9.0 kW	1.8– 9.0 kW
Without wiper  Manual wiper  Automatic wiper 	Without wiper  Manual wiper  Automatic wiper 	Without wiper  Manual wiper  Automatic wiper 	Without wiper  Manual wiper  Automatic wiper 
Temperature sensor UV sensor Modbus connection TS touch display	Temperature sensor UV sensor Modbus connection TS touch display	Temperature sensor UV sensor Modbus connection TS touch display	Temperature sensor UV sensor Modbus connection TS touch display
-	-	-	-

# Product comparison - health risks



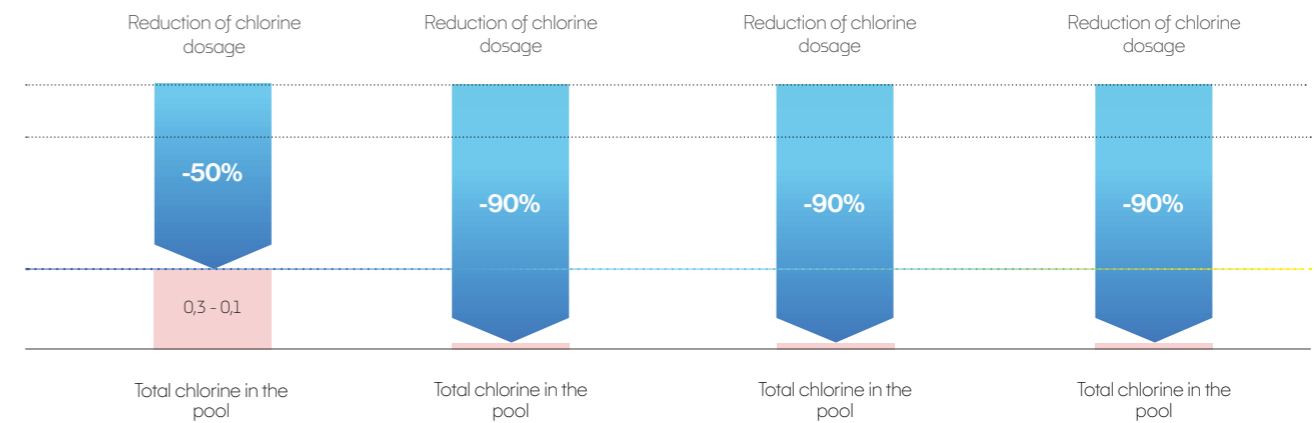
ProfiPure      ProfiTiny      Charm      Clear PRO

Bacteria Elimination	Yes	Yes	Yes	Yes
Viruses Elimination	Yes	Yes	Yes	Yes
Iron and manganese oxidation	-	-	-	-
Removes Trichloramines	Yes	Yes	Yes	Yes
Removes taste and odor	-	-	-	-
Removes Organic pollutant TOC (Total Organic Carbon)	-	-	-	-
Algae Elimination	Yes	Yes	Yes	Yes
Pathogens Elimination	Yes	Yes	Yes	Yes
Hazardous contaminants Elimination	-	-	-	-
Organic pollutants (BTEX, POPs, AOX, etc.) Elimination	-	-	-	-
Prevents collapse of the hall	Yes	Yes	Yes	Yes
Removes typical pool smell	Yes	Yes	Yes	Yes
Prevents irritation and drying of the skin	Yes	Yes	Yes	Yes
Swimming without red eyes	Yes	Yes	Yes	Yes
Prevents coughing and difficulty breathing	Yes	Yes	Yes	Yes
Prevents premature skin aging	Yes	Yes	Yes	Yes



Top      LifeOX® M10,20      LifeOX® M40      LifeOX® M90,140,250

Bacteria Elimination	Yes	Yes	Yes	Yes
Viruses Elimination	Yes	Yes	Yes	Yes
Iron and manganese oxidation	-	Yes	Yes	Yes
Removes Trichloramines	Yes	Yes	Yes	Yes
Removes taste and odor	-	Yes	Yes	Yes
Removes Organic pollutant TOC (Total Organic Carbon)	-	Yes	Yes	Yes
Algae Elimination	Yes	Yes	Yes	Yes
Pathogens Elimination	Yes	Yes	Yes	Yes
Hazardous contaminants Elimination	-	Yes	Yes	Yes
Organic pollutants (BTEX, POPs, AOX, etc.) Elimination	-	Yes	Yes	Yes
Prevents collapse of the hall	Yes	Yes	Yes	Yes
Removes typical pool smell	Yes	Yes	Yes	Yes
Prevents irritation and drying of the skin	Yes	Yes	Yes	Yes
Swimming without red eyes	Yes	Yes	Yes	Yes
Prevents coughing and difficulty breathing	Yes	Yes	Yes	Yes
Prevents premature skin aging	Yes	Yes	Yes	Yes



# Comparative technology - health risks

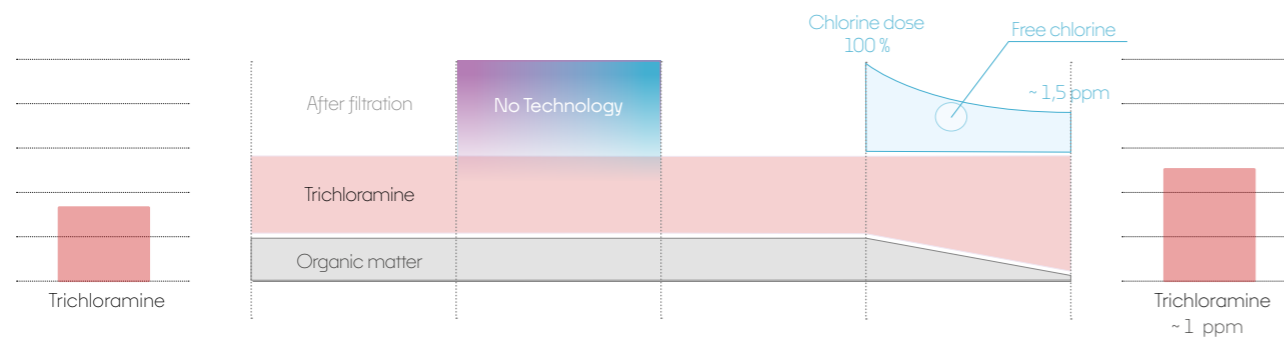
## Chlorination only

The chemical compound trichloramine (Part of combined chlorine) becomes carcinogenic at high concentrations and can trigger asthma, allergies, skin irritation and dryness, and eye irritation. It is the compound behind the typical "chlorine" smell associated with swimming pools. In essence, a pool with a strong chlorine smell indicates high levels of bound chlorine and is NOT healthy. Additionally, trichloramine contributes to the corrosion of materials within

swimming pools and indoor pool structures. Pools with chlorination and filtration only are prone to chlorine-resistant bacteria such as *Pseudomonas aeruginosa*, *Legionella*, *Mycobacterium avium*, and *Cryptosporidium*. These bacteria can withstand typical chlorine concentrations found in pools and can cause severe or even deadly illnesses. The parasite *giardia lamblia* – causes severe diarrhoea.

- ✗ Disinfection
- ✗ Trichloramine reduction
- ✗ Organic matter reduction

» Swimming pool with high concentrations with trichloramines, NOT a healthy pool

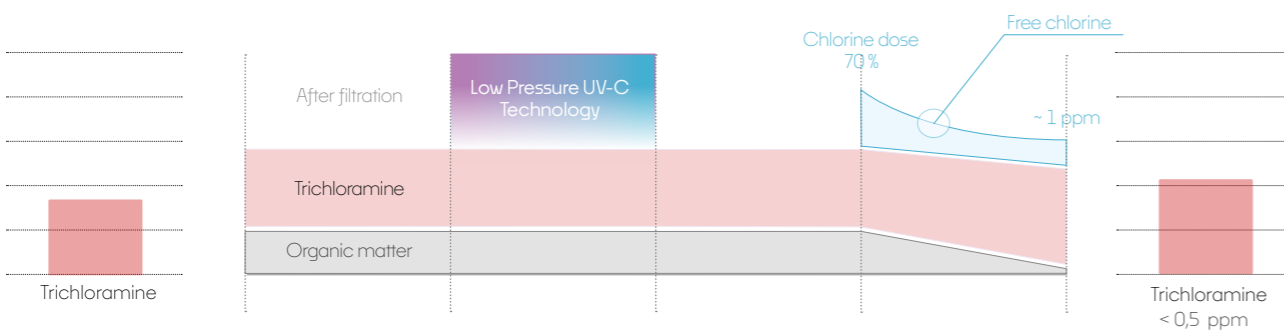


## Low Pressure UV

That harsh "chlorine pool" smell? It's actually trichloramine, a chemical compound of bound chlorine that is carcinogenic at higher concentrations and linked to asthma, skin irritation, and even damage to pool equipment. The concentration of disinfecting chlorine can be reduced to 0.5 mg/l. The concentration of disinfecting chlorine is 0.7-1 mg/l. Chlorine dosage 100%

» These lamps are based on low-pressure UV light bulbs with single wavelength of UV. These lamps do NOT remove the harmful trichloramine!

- ✓ Disinfection
- ✗ Trichloramine reduction
- ✗ Organic matter reduction



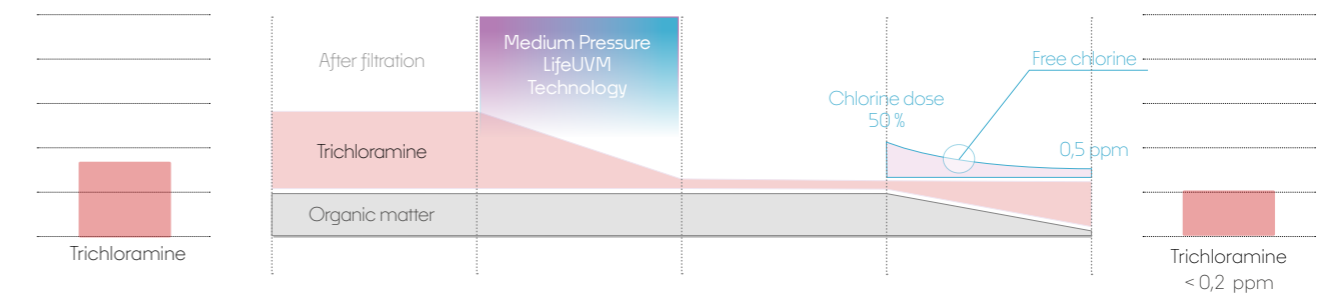
## Medium Pressure LifeUVM®

Ensure healthy water and a pleasant environment with UV systems featuring medium-pressure UV lamps, which simultaneously disinfect water and remove harmful Trichloramine. Standard low-pressure UV lamps cannot achieve this, which is why the German standard DIN 19643 for public swimming pool water treatment mandates the use of UV systems with medium-pressure lamps. This advanced technology, previously exclusive to

public pools, is now available for private pools. It also allows for the reduction of disinfecting chlorine concentration to 0.3 mg/l.

» Get a healthy swimming pool, removes the harmful Trichloramine

- ✓ Disinfection
- ✓ Trichloramine reduction
- ✗ Organic matter reduction



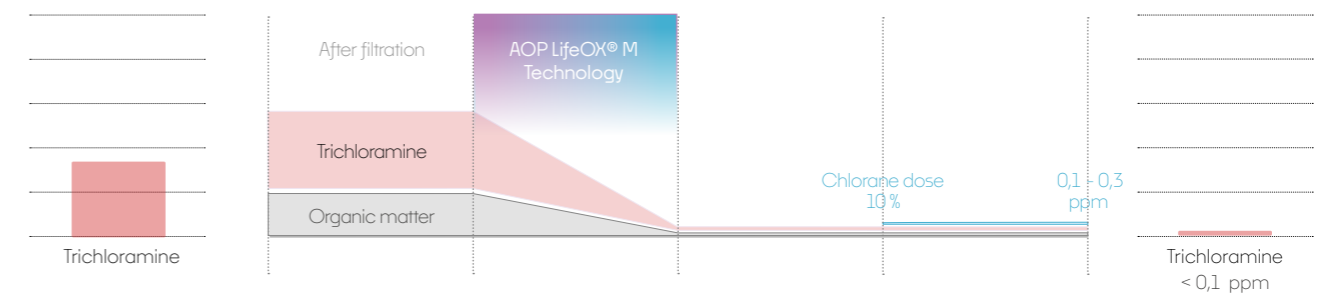
## AOP LifeOX® M

The pool water attains the quality of drinking water, creating a healthy and pleasant environment suitable even for toddlers, asthmatics, and allergy sufferers. It is free from harmful Trichloramine and organic TOC (Total Organic Carbon) contaminants. The concentration of disinfecting chlorine can be reduced to

0.1-0.2 mg/l. This results in a radical reduction of operating costs and the fastest return on investment.

» Most powerful technology available. Get a healthy swimming pool, removes harmful Trichloramine and its source. Reduce TOC (Total organic carbon)

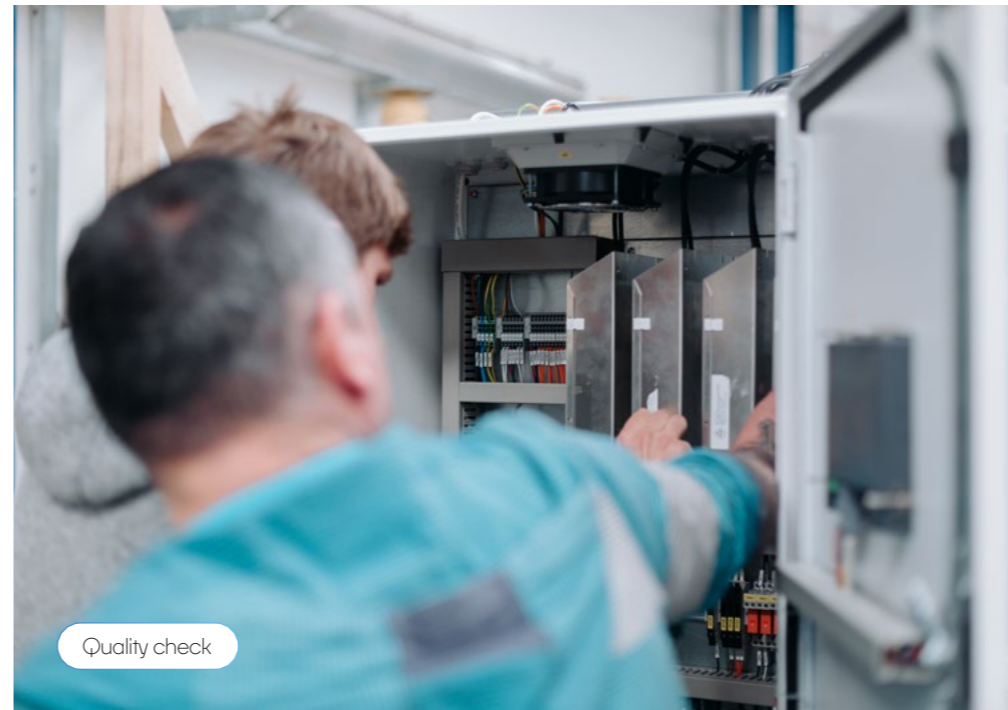
- ✓ Purification
- ✓ Trichloramine reduction
- ✓ Organic matter reduction



From drawing to wrapping.  
Everything under the hands  
of Lifetech workers and  
designers. We know every  
detail of our product and we  
stand behind it.



Compact solution



Quality check



Stainless steel design



LESS CHLORINE  
MORE HEALTH

Public pools - UVM, AOP v2026-04

## Contact

[www.lifetechozone.com](http://www.lifetechozone.com)

Sales Department  
[sales@lifetechozone.com](mailto:sales@lifetechozone.com)

Service Department  
[service@lifetechozone.com](mailto:service@lifetechozone.com)

LIFETECH s.r.o.  
Kosinova 19  
612 00 Brno  
Czech Republic

reg ID: 25504401  
VAT ID: CZ25504401



[www.lifetechozone.com](http://www.lifetechozone.com)



[www.instagram.com/  
lifetech\\_ozone\\_uv\\_aop\\_  
\\_expert/](https://www.instagram.com/lifetech_ozone_uv_aop_expert/)



[www.linkedin.com/  
company/lifetech-s-r-o-](https://www.linkedin.com/company/lifetech-s-r-o/)



[www.lifeox-m.lifetechozone.com/  
en/](http://www.lifeox-m.lifetechozone.com/en/)